

Alape[®]

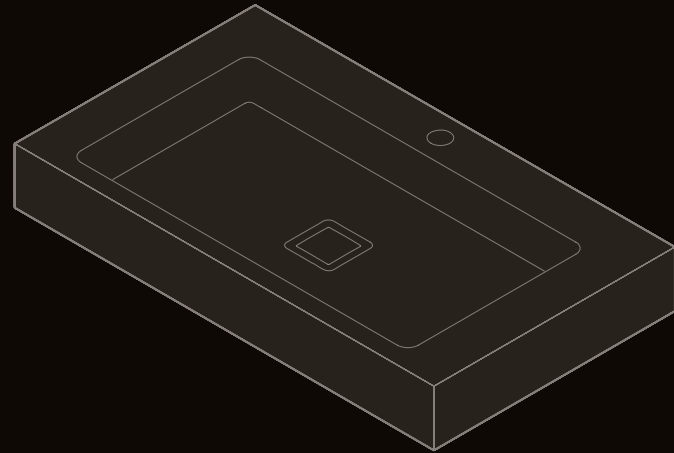

A³system addit



Jeder Mensch hat einen unverwechselbaren Charakter. In der Gestaltung seiner Lebensräume zeigt sich seine ganze Individualität. Am Waschplatz steht sich der Mensch selbst gegenüber – im Spiegel der eigenen Persönlichkeit. Every human being has unique characteristics. The way we create our living space reflects this individuality. At the washplace we come face to face with ourselves – the mirror of our own personality.

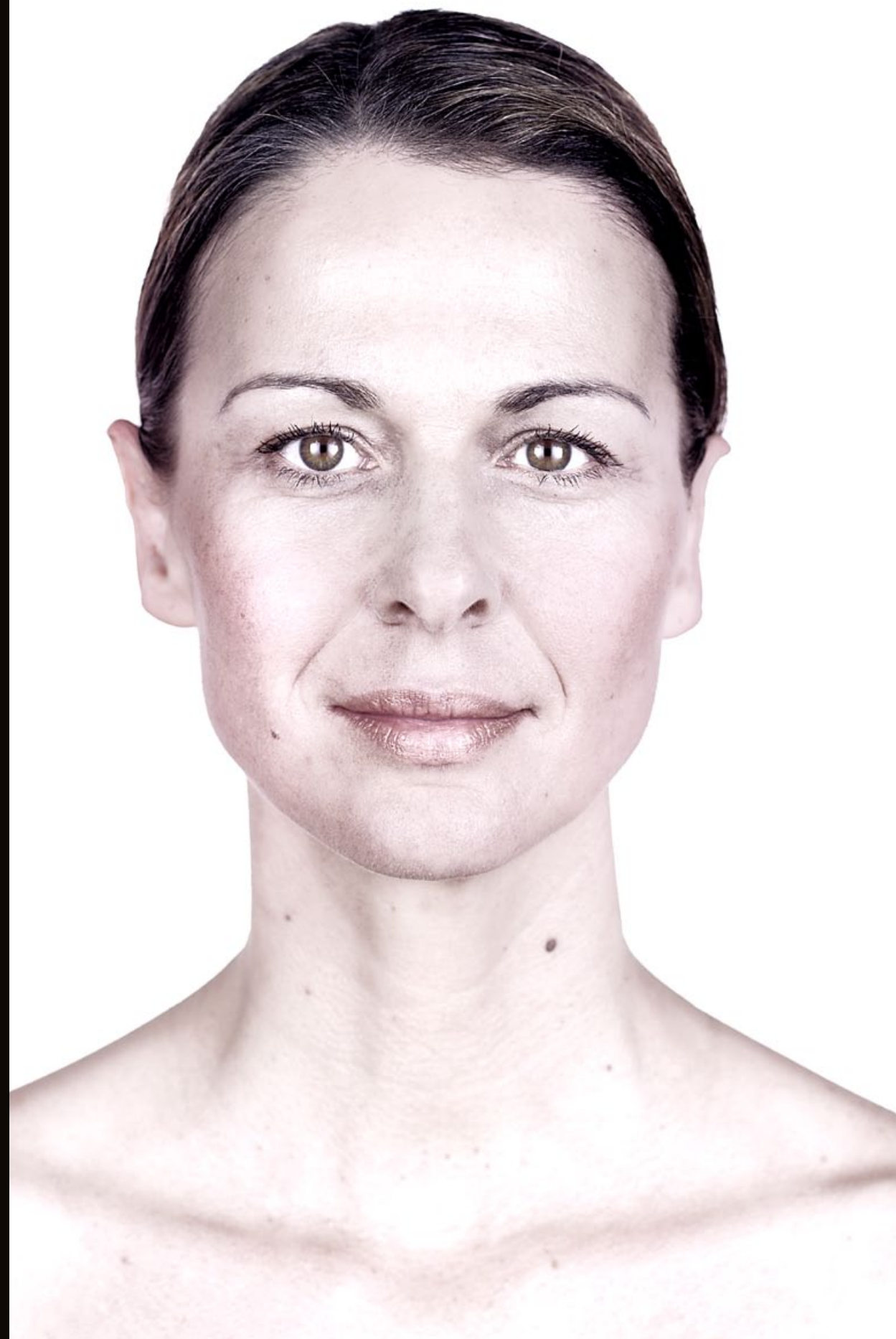

A'system addit ist das modulare Möbelprogramm für Alape Waschtische in reduziert puristischer Form. Es bietet eine Vielzahl an Möglichkeiten, den Waschplatz ganz persönlich zu gestalten.

A'system addit is the modular furniture programme for Alape washstands and pursues a minimalist and purist design style. It is designed to open up a range of possibilities for creating unique washplaces that have a personal touch.

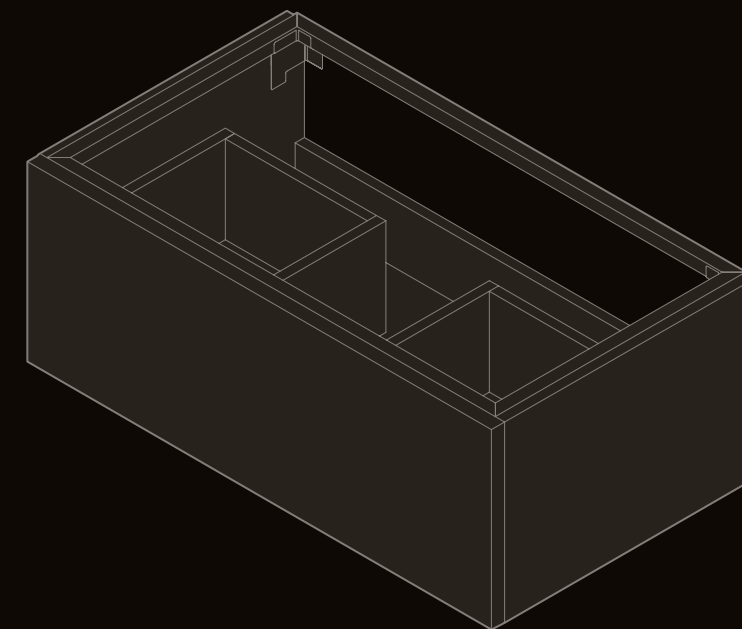

A'system addit

So funktioniert A~system addit

This is how A~system addit works

1

Waschtische
Washstands

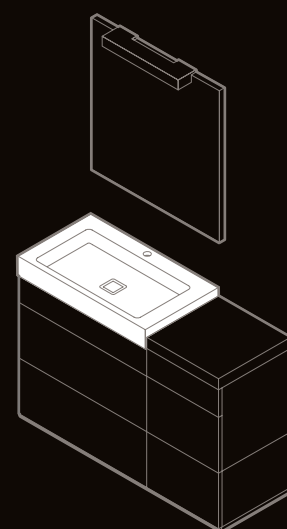

Wählen Sie Ihren aus glasiertem Stahl gefertigten Waschtisch. Ihnen stehen hierbei 24 Modelle zur Auswahl, die nach sechs unterschiedlichen Muldenformen kategorisiert sind.
Choose one of our 24 glazed steel washstands, which come with six different basic basin shapes.

2

Möbel
Furniture

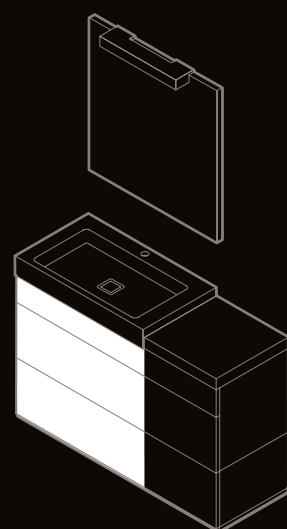

Passend zum Waschtisch können Sie sich Ihr Möbel zusammenstellen. Sie haben insgesamt die Auswahl zwischen fünf Höhen, vier Breiten und zwei Tiefen.
Choose a furniture module for your washstand. These are available in five different heights, four different widths and two different depths.

3

Weitere Möbel
Additional furniture

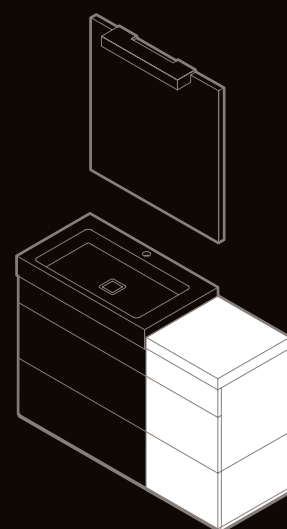

Ergänzen Sie ggf. weitere Möbelmodule mit Trägerplatten oder Tableaus. Gestalten Sie mit den Möbelmodulen Sideboards oder aus bodenstehenden Modulen Sitzbänke. Kombinieren Sie Hochschränke und Zubehör wie Handtuchhalter.
Choose additional furniture modules, which are available with either a counter top or tableau and can be used to create sideboards or floor-standing benches. Add tall cupboards for extra storage and select accessories like towel rails.

4

Oberflächen
Surfaces

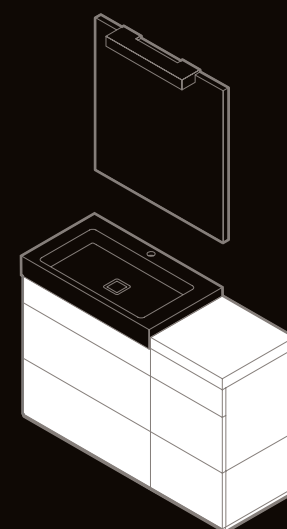

Alle Möbel sind in fünf unterschiedlichen Holzönen und Oberflächen erhältlich. Eine Klappseite am Umschlag veranschaulicht alle Materialien auf einen Blick.
All furniture modules are available in five different wood finishes and surfaces. Please see the fold-out page at the back of this brochure for samples of these finishes.

5

Spiegel / Leuchten
Mirrors / lighting

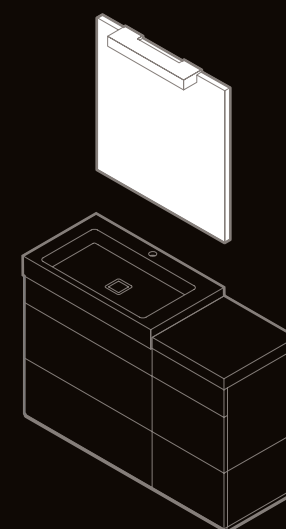

Runden Sie Ihren individuellen Waschplatz mit Funktionskomponenten wie Spiegeln und Leuchten ab.
Add a personal touch to your washplace with functional elements like mirrors and lights.



Möbel und Trägerplatte aus Echtholz furnier Eiche anthrazit / Waschtisch WT.GR1250H.L / Spiegel SP.1 mit Leuchte LE.7
Furniture and counter top made of real wood veneer, oak anthracite / Washstand WT.GR1250H.L / Mirror SP.1 with light LE.7





Möbel und Trägerplatten aus Echtholz furnier Nussbaum / Waschtische WT.RE800H / Spiegel SP.1 mit Leuchten LE.3
Furniture and counter tops made of real wood veneer, hazelnut / Washstands WT.RE800H / Mirror SP.1 with lights LE.3

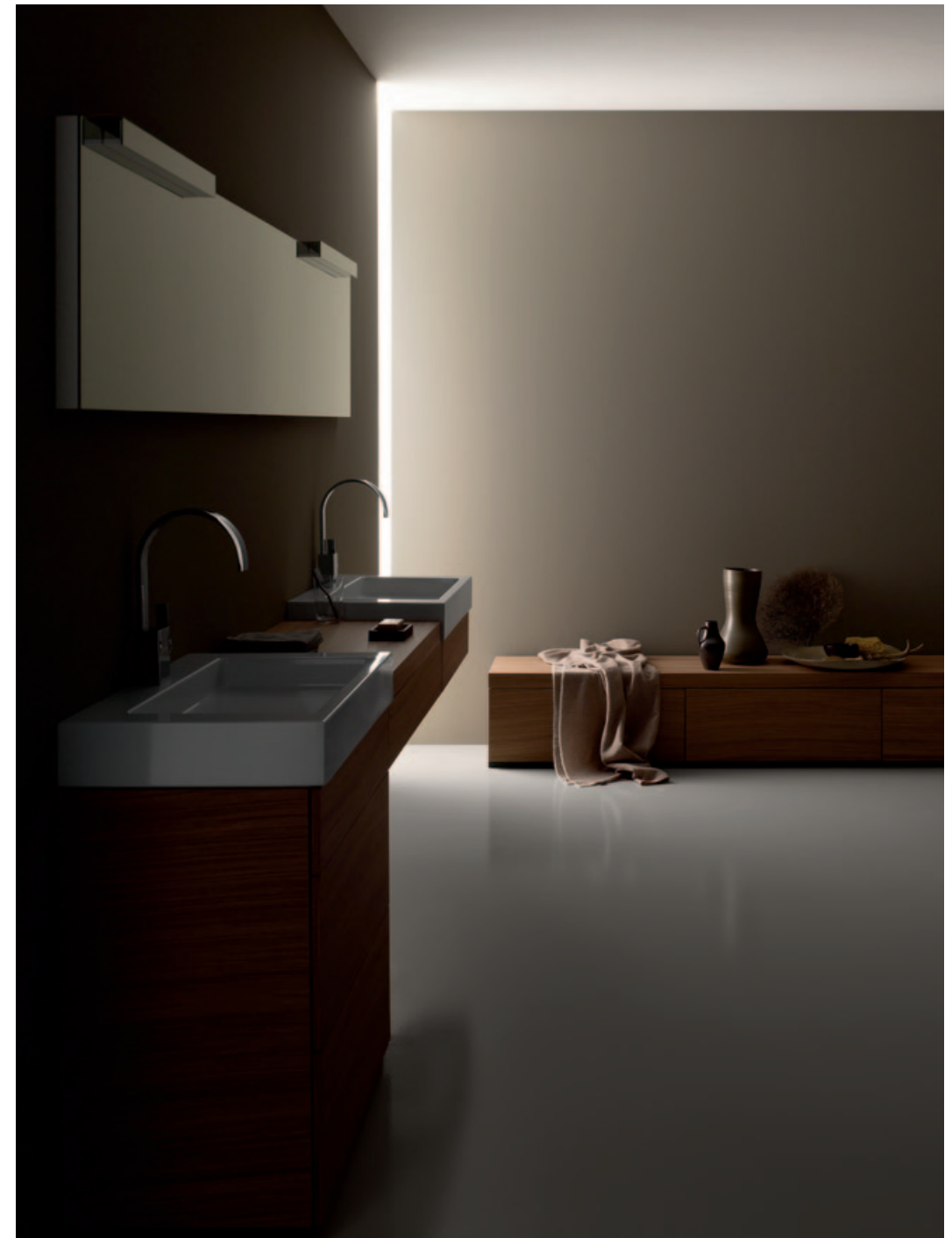



Möbel und Trägerplatten aus Echtholz furnier Eiche anthrazit mit Handtuchhalter HTH.325.S1 / Waschtische WT.QS450HX / Spiegel SP.450.1 mit Leuchte LE.4 / Hochschrank HS.1600.L Furniture and counter tops made of real wood veneer, oak anthracite, with towel rail HTH.325.S1 / Washstands WT.QS450HX / Mirrors SP.450.1 with light LE.4 / tall cupboard HS.1600.L





Möbel und Trägerplatte aus Echtholz furnier Eiche hell / Waschtisch WT.QS450HX / Vertikalspiegel SPV.1400
Furniture and counter top made of real wood veneer, oak light / Washstand WT.QS450HX / Vertical mirror SPV.1400





Möbel und Trägerplatte aus Holzdekor Walnuss / Waschtisch WT.RX450QS.1 / Vertikalspiegel SPV.1400
Furniture and counter top made of wood effect laminate, walnut / Washstand WT.RX450QS.1 / Vertical mirror SPV.1400





Möbel und Trägerplatte aus Holzdekor Graueiche/Waschtische WT.RX450MC.1/Spiegel SP.1 mit Leuchten LE.7
Furniture and counter top made of wood effect laminate, grey oak/Washstands WT.RX450MC.1/Mirror SP.1 with lights LE.7









Möbel und Trägerplatte aus Holzdekor Walnuss / Waschtisch WT.MC800 / Spiegel SP.2 mit Leuchten LE.2
Furniture and counter top made of wood effect laminate, walnut / Washstand WT.MC800 / Mirror SP.2 with lights LE.2



Möbel und Trägerplatte aus Holzdekor Walnuss mit Handtuchhalter HTH.800.KS1 / Waschtisch WT.MC800 / Spiegel SP.2 mit Leuchten LE.2 Furniture and counter top made of wood effect laminate, walnut, with towel rail HTH.800.KS1 / Washstand WT.MC800 / Mirror SP.2 with lights LE.2



Möbel und Tableau aus Holzdekor Graueiche / Waschtisch WT.GR1250.L mit Handtuchhalter HTH.320.R1 / Spiegel SP.2 mit Leuchte LE.3
Furniture and tableau made of wood effect laminate, grey oak / Washstand WT.GR1250.L with towel rail HTH.320.R1 / Mirror SP.2 with light LE.3





Möbel und Tableau aus Holzdekor Graueiche mit Handtuchhalter HTH.1000.KS1 / Waschtisch WT.PR600H / Spiegel SP.580 mit Leuchte LE.4
Furniture and tableau made of wood effect laminate, grey oak, with towel rail HTH.1000.KS1 / Washstand WT.PR600H / Mirror SP.580 with light LE.4



Möbel und Trägerplatte aus Echtholz furnier Eiche hell / Waschtische WT.GR800H / Spiegel SP.2 mit Leuchten LE.2
Furniture and counter top made of real wood veneer, oak light / Washstands WT.GR800H / Mirror SP.2 with lights LE.2

Modulvarianten Module versions

A'system addit bietet für jede Raumsituation und architektonische Anforderung die passende Lösung. Die folgenden Modulvarianten zeigen eine Auswahl an Möglichkeiten des modularen Möbelsystems und dienen als Inspiration zur individuellen Gestaltung Ihres Waschplatzes. A'system addit offers appropriate solutions for every kind of room and all architectural requirements. The modules below show a few of the ways in which our modular units can be combined and are shown to inspire you in the design of your own washplace.

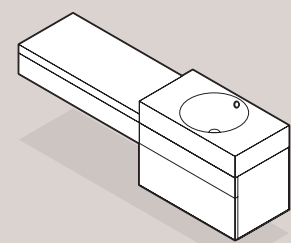

1

Waschtisch WT.MC800
Möbelmodul MB.H4.800.4S
Möbelmodul MB.H1.1000.4
Trägerplatte TP.HO375.1000
Washstand WT.MC800
Furniture module MB.H4.800.4S
Furniture module MB.H1.1000.4
Counter top TP.HO375.1000

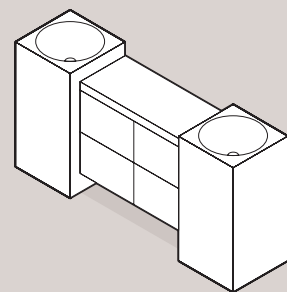
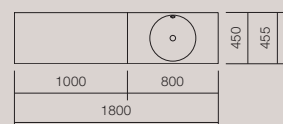
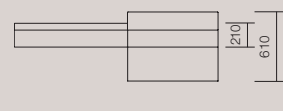

2

Waschtische WT.RX450MC.1 bodenstehend
Möbelmodule MB.H6.450.3
Trägerplatte TP.HO375.900
Washstands WT.RX450MC.1 floor-standing
Furniture modules MB.H6.450.3
Counter top TP.HO375.900

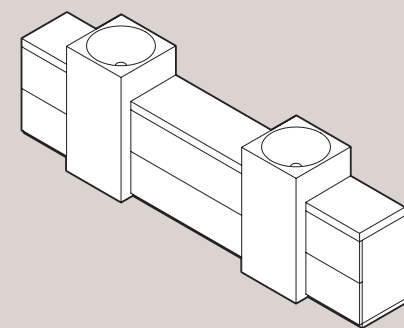
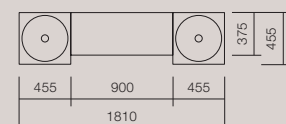
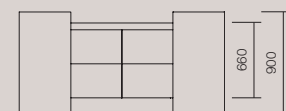

3

Waschtische WT.RX450MC.1 bodenstehend
Möbelmodule MB.H6.450.3B bodenstehend
Möbelmodul MB.H6.1000.3B bodenstehend
Trägerplatten TP.HO375.450
Trägerplatte TP.HO375.1000
Washstands WT.RX450MC.1 floor-standing
Furniture modules MB.H6.450.3B floor-standing
Furniture module MB.H6.1000.3B floor-standing
Counter tops TP.HO375.450
Counter top TP.HO375.1000

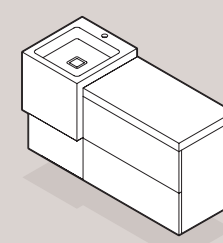
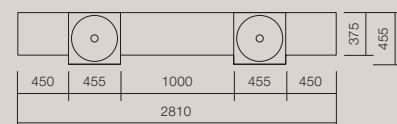
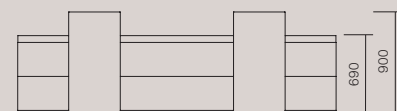

4

Waschtisch WT.QS450HX
Möbelmodul MB.H6.800.4
Möbelmodul MB.H3.450.4
Trägerplatte TP.HO450.800
Washstand WT.QS450HX
Furniture module MB.H6.800.4
Furniture module MB.H3.450.4
Counter top TP.HO450.800

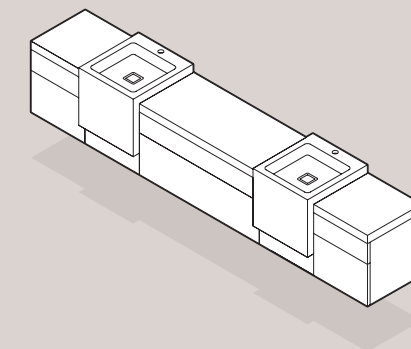
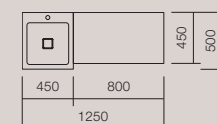
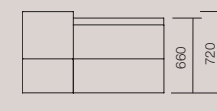

5

Waschtische WT.QS450HX
Möbelmodule MB.H4.450.4
Möbelmodul MB.H4.1000.4
Möbelmodule MB.H1.450.4
Trägerplatten TP.HO450.450
Trägerplatte TP.HO450.1000
Washstands WT.QS450HX
Furniture modules MB.H4.450.4
Furniture module MB.H4.1000.4
Furniture modules MB.H1.450.4
Counter tops TP.HO450.450
Counter top TP.HO450.1000

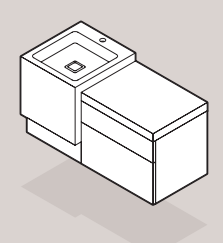
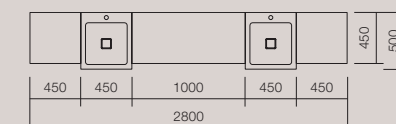
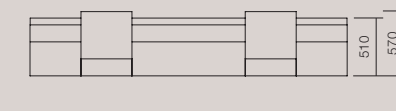

6

Waschtisch WT.QS450HX
Möbelmodul MB.H4.600.4
Möbelmodul MB.H1.450.4
Trägerplatte TP.HO450.600
Washstand WT.QS450HX
Furniture module MB.H4.600.4
Furniture module MB.H1.450.4
Counter top TP.HO450.600

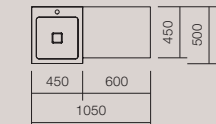
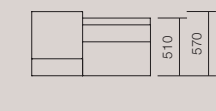

Modulvarianten Module versions

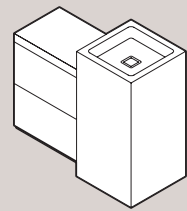

7

Waschtisch WT.RX450QS.1
Möbelmodul MB.H6.600.3B
Trägerplatte TP.HO375.600
Waschstand WT.RX450QS.1
Furniture module MB.H6.600.3B
Counter top TP.HO375.600

bodenstehend
bodenstehend
floor-standing
floor-standing

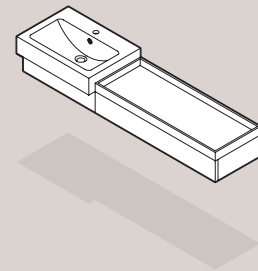
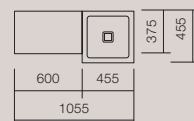
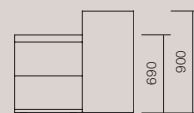

8

Waschtisch WT.PR600H
Möbelmodul MB.H1.600.3S
Möbelmodul MB.H1.1000.3
Tableau TP.HO375.1000T
Waschstand WT.PR600H
Furniture module MB.H1.600.3S
Furniture module MB.H1.1000.3
Tableau TP.HO375.1000T

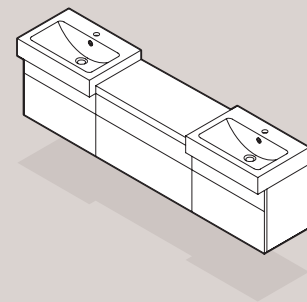
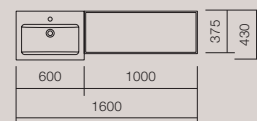
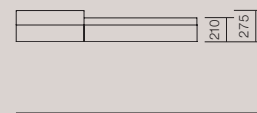

9

Waschtische WT.PR600H
Möbelmodule MB.H4.600.3S
Möbelmodul MB.H4.800.3
Trägerplatte TP.HO375.800
Waschstands WT.PR600H
Furniture modules MB.H4.600.3S
Furniture module MB.H4.800.3
Counter top TP.HO375.800

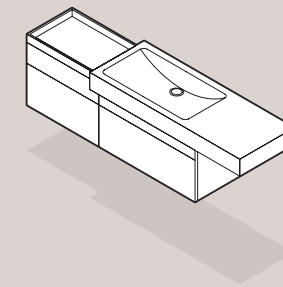
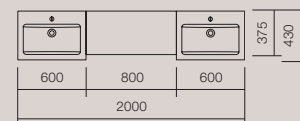
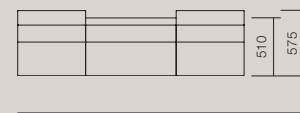

10

Waschtisch WT.GR1250.L
Möbelmodul MB.H4.800.3S
Möbelmodul MB.H4.600.3
Tableau TP.HO375.600T
Waschstand WT.GR1250.L
Furniture module MB.H4.800.3S
Furniture module MB.H4.600.3
Tableau TP.HO375.600T

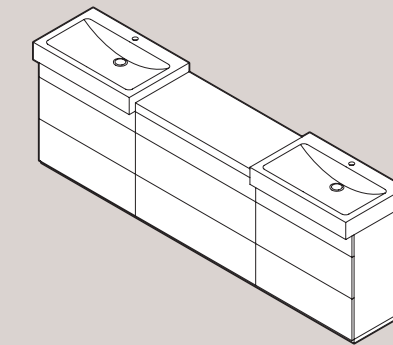
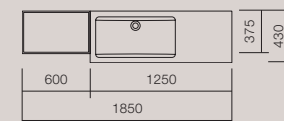
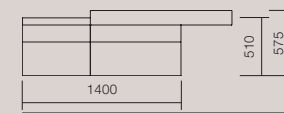

11

Waschtische WT.GR800H
Möbelmodule MB.H7.800.4SB
Möbelmodul MB.H7.1000.4B
Trägerplatte TP.HO450.1000
Waschstands WT.GR800H
Furniture modules MB.H7.800.4SB
Furniture module MB.H7.1000.4B
Counter top TP.HO450.1000

bodenstehend
bodenstehend
floor-standing
floor-standing

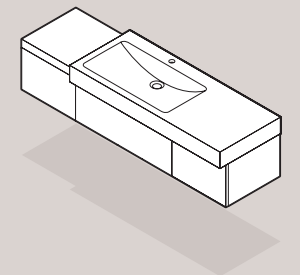
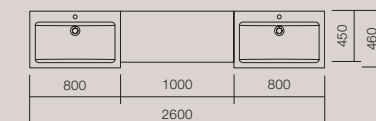
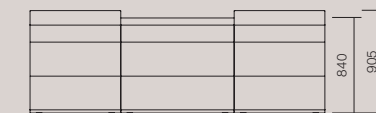

12

Waschtisch WT.GR1250H.L
Möbelmodule MB.H3.450.4
Möbelmodul MB.H3.800.4S
Trägerplatte TP.HO450.450
Waschstand WT.GR1250H.L
Furniture modules MB.H3.450.4
Furniture module MB.H3.800.4S
Counter top TP.HO450.450

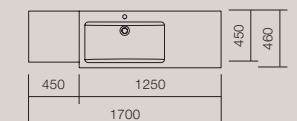
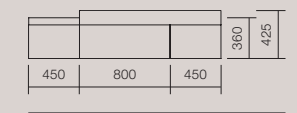

Modulvarianten Module versions

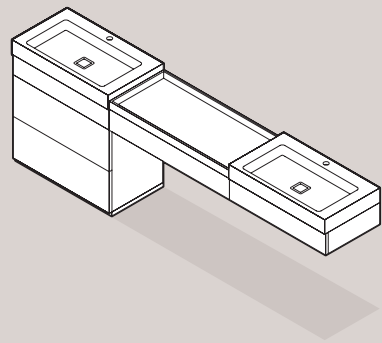

13

Waschtische WT.RE800H
Möbelmodul MB.H7.800.4SB bodenstehend
Möbelmodul MB.H1.1000.4
Möbelmodul MB.H1.800.4S
Tableau TP.HO450.1000T
Washstands WT.RE800H
Furniture module MB.H7.800.4SB floor-standing
Furniture module MB.H1.1000.4
Furniture module MB.H1.800.4S
Tableau TP.HO450.1000T

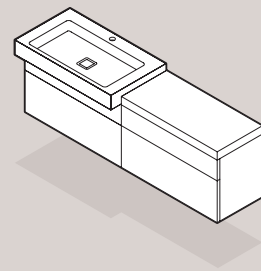
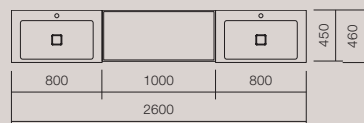
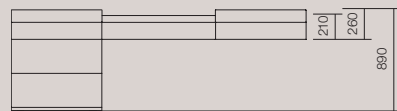

14

Waschtisch WT.RE800H
Möbelmodul MB.H4.800.3S
Möbelmodul MB.H4.800.3
Trägerplatte TP.HO375.800
Washstand WT.RE800H
Furniture module MB.H4.800.3S
Furniture module MB.H4.800.3
Counter top TP.HO375.800

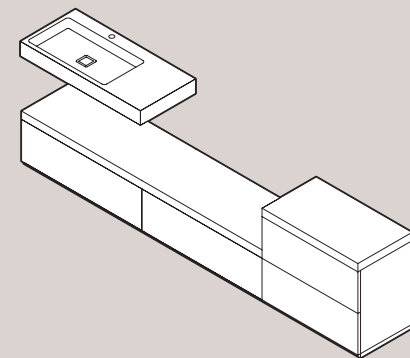
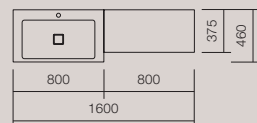
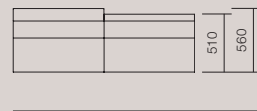

15

Waschtisch WT.RE1000H.L
Möbelmodule MB.H3.1000.4B bodenstehend
Möbelmodul MB.H6.800.4B bodenstehend
Trägerplatte TP.HO450.2000
Trägerplatte TP.HO450.800
Washstand WT.RE1000H.L
Furniture modules MB.H3.1000.4B floor-standing
Furniture module MB.H6.800.4B floor-standing
Counter top TP.HO450.2000
Counter top TP.HO450.800

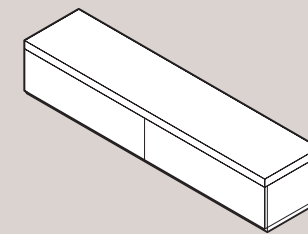
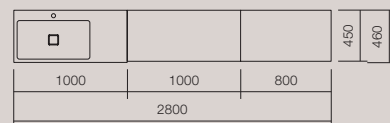
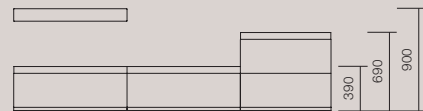

16

Möbelmodule MB.H3.1000.4B bodenstehend
Trägerplatte TP.HO450.2000
Furniture modules MB.H3.1000.4B floor-standing
Counter top TP.HO450.2000

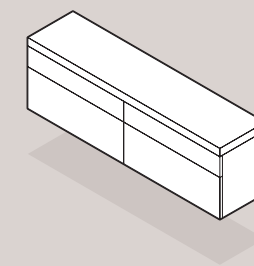
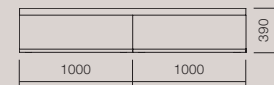

17

Möbelmodule MB.H4.800.3
Trägerplatte TP.HO375.1600
Furniture modules MB.H4.800.3
Counter top TP.HO375.1600

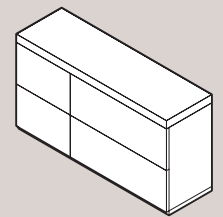
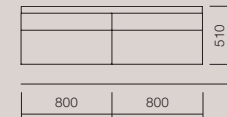

18

Möbelmodul MB.H6.450.3B bodenstehend
Möbelmodul MB.H6.800.3B bodenstehend
Trägerplatte TP.HO375.1250
Furniture module MB.H6.450.3B floor-standing
Furniture module MB.H6.800.3B floor-standing
Counter top TP.HO375.1250

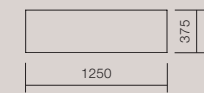
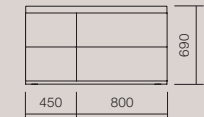

Waschtische Washstands

Gefertigt aus glasiertem Stahl, stehen mit A³system addit 24 verschiedene Waschtische mit sechs unterschiedlichen Beckenmulden zur Auswahl. Dieser für Alape charakteristische Werkstoff eröffnet eine faszinierende Vielfalt an Formen in einzigartiger Präzision. Fitted with glazed steel basins, A³system addit comprises 24 different washstands with six different basin shapes to choose from. The use of glazed steel is a characteristic of Alape and is a material that opens up a fascinating choice of shapes and precision finishes.

MC

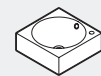

WT.MC450H
450 x 455 x 160
375/450 *

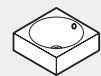

WT.MC450
450 x 455 x 160
375/450 *

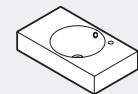

WT.MC800H
800 x 455 x 160
375/450 *

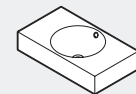

WT.MC800
800 x 455 x 160
375/450 *

QS

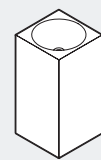

WT.RX450MC.1
450 x 455 x 900
375/450 *

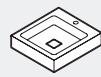

WT.QS450H
450 x 500 x 110
375/450 *



WT.QS450
450 x 450 x 110
375 *

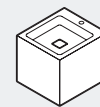

WT.QS450HX
450 x 500 x 420
375/450 *

PR

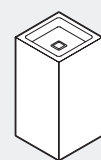

WT.RX450QS.1
455 x 455 x 900
375/450 *

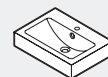

WT.PR600H
600 x 430 x 125
375 *



WT.PR600
600 x 430 x 125
375 *

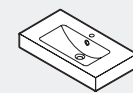

WT.PR800H.1
800 x 430 x 125
375 *

* geeignet für diese Möbeltiefen
* suitable for furniture with these depths

alle Maße in mm (B x T x H)
all dimensions in mm (W x D x H)

GR

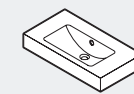

WT.PR800.1
800 x 430 x 125
375 *

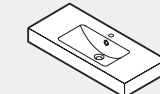

WT.PR1000H.1
1000 x 430 x 125
375 *

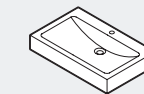

WT.GR800H
800 x 500 x 125
375/450 *

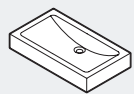

WT.GR800
800 x 455 x 125
375/450 *

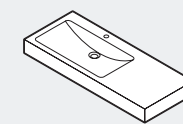

WT.GR1250H.L
1250 x 500 x 125
375/450 *

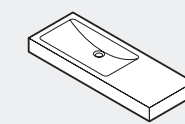

WT.GR1250.L
1250 x 455 x 125
375/450 *

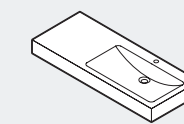

WT.GR1250H.R
1250 x 500 x 125
375/450 *

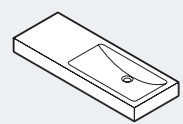

WT.GR1250.R
1250 x 455 x 125
375/450 *

RE

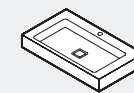

WT.RE800H
800 x 460 x 110
375/450 *

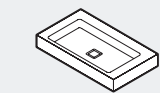

WT.RE800
800 x 460 x 110
375/450 *

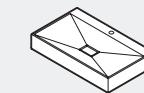

WT.KF800H
800 x 475 x 125
375/450 *

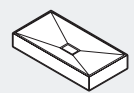

WT.KF800
800 x 400 x 125
375 *

* geeignet für diese Möbeltiefen
* suitable for furniture with these depths

alle Maße in mm (B x T x H)
all dimensions in mm (W x D x H)

Möbelmodule Furniture modules

A^{system} addit Möbelmodule umfassen Schubladen aus hochwertigen Materialien, die in fünf Höhen (150, 300, 450, 600, 750 mm), vier Breiten (450, 600, 800, 1000 mm) und zwei Tiefen (375, 450 mm) erhältlich sind. Je nach Ausstattung der Möbelmodule variieren die zur Auswahl stehenden Breiten- und Tiefenmaße. Bodenstehende Varianten, mit denen auch Sideboards oder Sitzbänke gestaltet werden können, stehen in den Höhen 300, 600 und 750 mm bereit.

150

450/600/800/1000 x 375 x 150
450/800 x 450 x 150

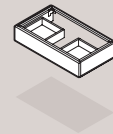

MB.H1 mit Siphonausschnitt
MB.H1 with siphon cutout

450/600/800/1000 x 375 x 150
450/600/800/1000 x 450 x 150

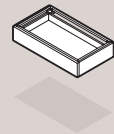

MB.H1 mit vollflächiger Schublade
MB.H1 with full size drawer

600/800/1000 x 375 x 150
600/800/1000 x 450 x 150

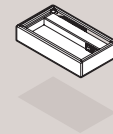

MB.H1 mit Doppelsteckdose
MB.H1 with twin power socket

300

450/600/800/1000 x 375 x 300
450/800 x 450 x 300

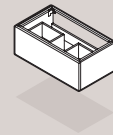

MB.H3 mit Siphonausschnitt
MB.H3 with siphon cutout

450/600/800/1000 x 375 x 300
450/600/800/1000 x 450 x 300

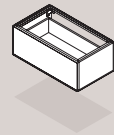

MB.H3 mit vollflächiger Schublade
MB.H3 with full size drawer

600/800/1000 x 375 x 300
600/800/1000 x 450 x 300

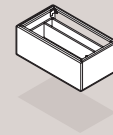

MB.H3 mit Doppelsteckdose
MB.H3 with twin power socket

450/600/800/1000 x 375 x 300
450/600/800/1000 x 450 x 300

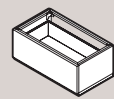

MB.H3 bodenstehend
MB.H3 floor-standing

450

450/600/800/1000 x 375 x 450
450/800 x 450 x 450

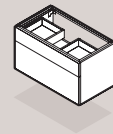

MB.H4 mit Siphonausschnitt
MB.H4 with siphon cutout

450/600/800/1000 x 375 x 450
450/600/800/1000 x 450 x 450

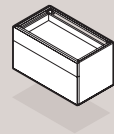

MB.H4 mit vollflächigen Schubladen
MB.H4 with full size drawer

600/800/1000 x 375 x 450
600/800/1000 x 450 x 450

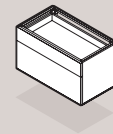

MB.H4 mit Doppelsteckdose
MB.H4 with twin power socket

alle Maße in mm (B x T x H)
all dimensions in mm (W x D x H)

600

450/600/800/1000 x 375 x 600
450/800 x 450 x 600

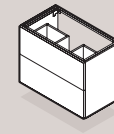

MB.H6 mit Siphonausschnitt
MB.H6 with siphon cutout

450/600/800/1000 x 375 x 600
450/600/800/1000 x 450 x 600

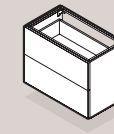

MB.H6 mit vollflächigen Schubladen
MB.H6 with full size drawer

600/800/1000 x 375 x 600
600/800/1000 x 450 x 600

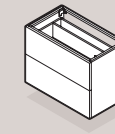

MB.H6 mit Doppelsteckdose
MB.H6 with twin power socket

450/600/800/1000 x 375 x 600
450/600/800/1000 x 450 x 600

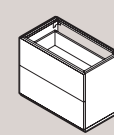

MB.H6 bodenstehend mit vollflächigen Schubladen
MB.H6 floor-standing with full size drawer

600/800/1000 x 375 x 600
600/800/1000 x 450 x 600

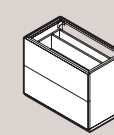

MB.H6 bodenstehend mit Doppelsteckdose
MB.H6 floor-standing with twin power socket

750

450/600/800/1000 x 375 x 750
450/800 x 450 x 750

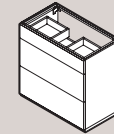

MB.H7 bodenstehend mit Siphonausschnitt
MB.H7 floor-standing with siphon cutout

450/600/800/1000 x 375 x 750
450/600/800/1000 x 450 x 750

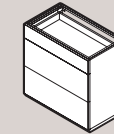

MB.H7 bodenstehend mit vollflächigen Schubladen
MB.H7 floor-standing with full size drawer

600/800/1000 x 375 x 750
600/800/1000 x 450 x 750

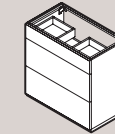

MB.H7 bodenstehend mit Siphonausschnitt und Doppelsteckdose
MB.H7 floor-standing with siphon cutout and twin power socket

600/800/1000 x 375 x 750
600/800/1000 x 450 x 750

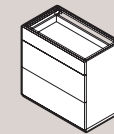

MB.H7 bodenstehend mit Doppelsteckdose
MB.H7 floor-standing with twin power socket

alle Maße in mm (B x T x H)
all dimensions in mm (W x D x H)

Trägerplatten, Tableaus und Hochschränke Counter tops, tableaus and tall cupboards

Zu den vorangegangenen Möbelmodulen ohne Siphonausschnitt gehört immer eine passende Trägerplatte oder ein Tableau. Beide haben eine Höhe von 60 mm und können in Breite und Tiefe exakt auf die gewünschte Modulkombination abgestimmt werden. Zusätzliche Stauraummöglichkeit geben Hochschränke, die das geradlinige Design des Möbelsystems fortsetzen. All of the furniture modules without siphon cutouts shown on the previous pages come either with a matching counter top or tableau. Both of these are 60 mm high and are available in widths and depths to match your chosen furniture combination. Tall cupboards are an ideal addition where extra storage is an issue and beautifully complement the clean design of this furniture system.

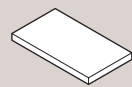

TP.HO
450 – 2000 × 60
375 / 450 *

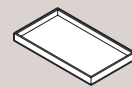

TP.HO.T
450 / 600 / 800 / 1000 × 60
375 / 450 *

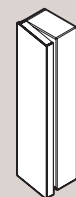

HS.1600.L/R
1600 × 400 × 320

* geeignet für diese Möbeltiefen
* suitable for furniture with these depths

alle Maße in mm (B × T × H)
all dimensions in mm (W × D × H)

Spiegel und Licht Mirrors and lighting

Abgerundet wird A`system addit durch Funktionskomponenten wie Spiegel und Leuchten. Neben vorgegebenen Maßen bietet Alape Planungsspielraum in individuell anpassbaren Spiegelbreiten und frei kombinierbaren Leuchten. The A`system addit can be rounded off with functional elements such as mirrors and lights. Next to specified dimensions, Alape also offers mirrors with individually adjustable widths and lights that can be freely combined to give you more options in the design of your washplace.



SP.450
450 × 45 × 800
+ LE.4/LE.6/LE.7



SP.580
580 × 45 × 800
+ LE.4/LE.6/LE.7

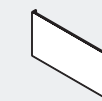

SP.1
800 – 3000 × 45 × 500
+ LE.1/LE.3/LE.4/LE.6/LE.7



SP.2
800 – 3000 × 45 × 800
+ LE.2/LE.3/LE.4/LE.6/LE.7



SPV.1400
600 × 45 × 1400



SPV.1700
600 × 45 × 1700



LE.1
71 × 49 × 440
1 × 36 W



LE.2
50 × 35 × 625
1 × 24 W

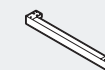

LE.3
625 × 35 × 50
1 × 24 W



LE.4
120 × 120 × 60
1 × 35 W



LE.6
80 × 120 × 120,5
1 × 35 W



LE.7
310 × 68 × 20
LED / 4,5 W

alle Maße in mm (B × T × H)
all dimensions in mm (W × D × H)

Oberflächen Surfaces

Glasierter Stahl
Glazed steel



Weiß
Farbnummer: 000
White
Colour code: 000

Holzdekor
Wood effect laminate



Walnuss
Farbnummer: 621
Walnut
Colour code: 621



Graueiche
Farbnummer: 620
Grey oak
Colour code: 620

Echtholz furnier
Real wood veneer



Eiche hell
Farbnummer: 688
Oak light
Colour code: 688



Nussbaum
Farbnummer: 676
Hazelnut
Colour code: 676



Eiche anthrazit
Farbnummer: 678
Oak anthracite
Colour code: 678

Impressum

Imprint

Editor	Alape GmbH, Goslar/D
Conception / Design	Martin et Karczinski, München/D
Product design	sieger design, Sassenberg/D
	busalt design, Traunreut/D
	Lykouria, London/UK
Photography	Thomas Popinger, Hamburg/D
Print	M + E Druckhaus, Belm/D

Modell-, Programm- und technische Änderungen sowie Irrtum vorbehalten. Aus drucktechnischen Gründen können sich bei einzelnen Abbildungen Farbabweichungen ergeben.

Subject to model, programme and technical alterations, errors excepted. For technical printing reasons, colour variations may occur in the individual illustration.

© Alape 2012 / Art. 0101 500012 / Printed in Germany 10/2012

D/GB 10/2012

Alape GmbH
Am Gräbicht 1-9
D-38644 Goslar

Postfach 1240
D-38602 Goslar

Tel + 49 (0) 53 21.558 - 0
Fax + 49 (0) 53 21.558 - 400
E-Mail info@alape.com

www.alape.com

Alape 