



MUSEUM

UNIQUE SURFACES

Museum is a brand name synonymous with deluxe ceramic tiles. Its elegant sophisticated products stand out for their high-tech modern identity, with the emphasis on innovation, design and a forward looking vision.

We channel our experience as a manufacturer and desire to evolve into keeping abreast of today's times.

Thanks to the addition of new formats, textures and finishes, our range offers even broader design potential as part of our commitment to guaranteeing exquisite, highly desirable products with a clearly distinctive hallmark.

¿Qué puede hacer un usuario registrado en museumsurfaces.com?

—

What can I do when I'm logged at museumsurfaces.com?

1. DOWNLOADS

- HD project pictures
- HD tiles images and patterns for 3d projects
- Tiles tech sheets

2. MARKETING

- Search and download catalogues
- Search and download promotional tools

3. INTRANET

- Check the stock in real time
- Packing info

4. 3D DESIGN

- Design your space with Museum product
- Render your project with HD quality

Visit our new website at www.museumsurfaces.com



Contacte con MUSEUM para conseguir su usuario y su contraseña
Contact with MUSEUM to obtain your user and password

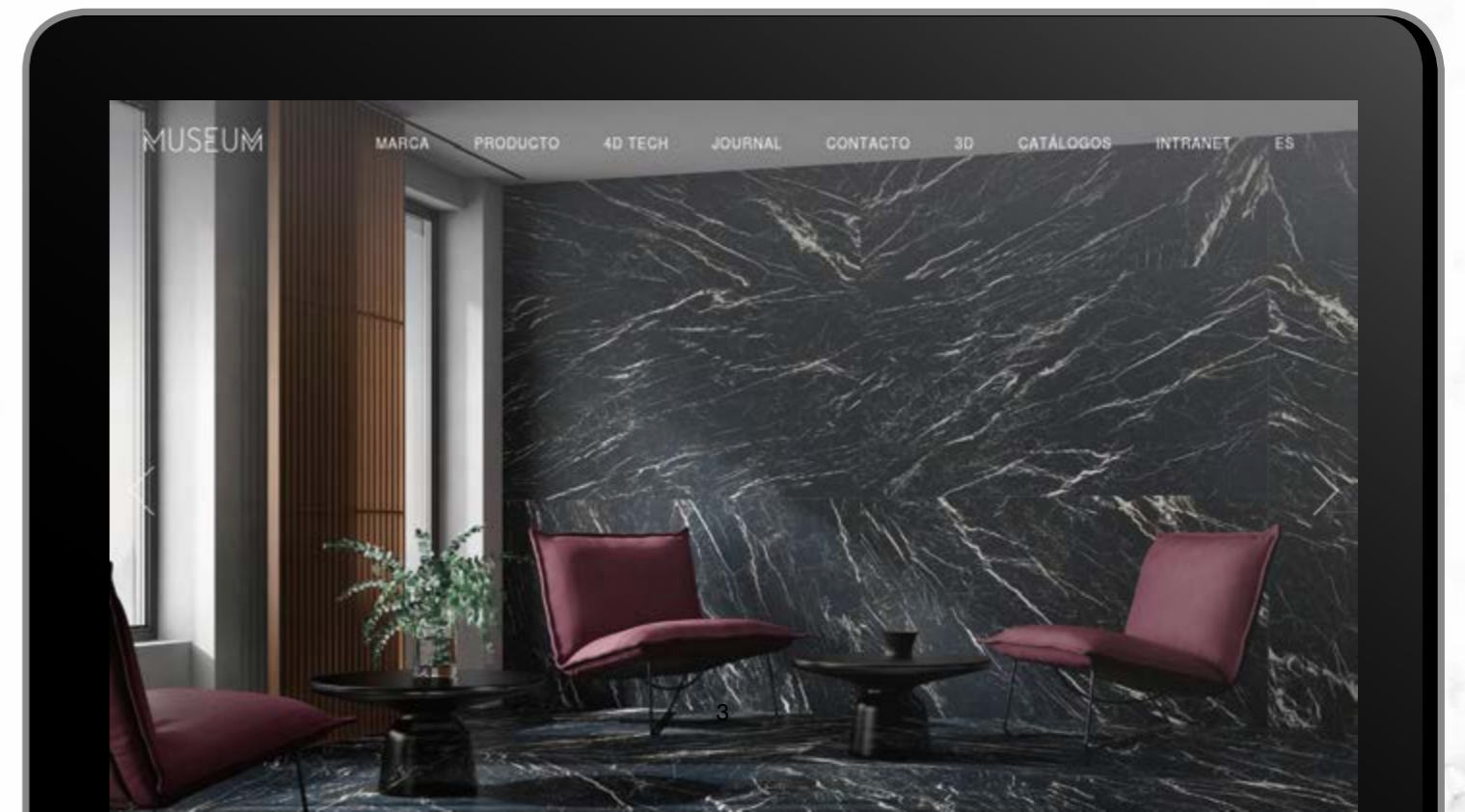



MUSEUM



16	CALACATTA 4D	192	STATE
20	DEEP 4D	196	STIAVA
26	ETERNAL 4D	202	SUNSHINE
32	RUGBY	208	GREVIN
42	SOLTO	212	LENS
54	SHERWOOD OAK	222	LUMINA
62	BARDIGLIO	226	MARQ
74	GREYSTONE	230	MENHIR
83	MARQUINA	234	TUCCI
92	STATUARIO PLUS	242	VOGUE
105	BASATI	246	AGATHA
110	NARA	252	CAPITAL
118	ONIX	256	MACBA
124	SANTANA		MUVIM
128	SUITE	262	OPALO
138	TORANO		BACH
146	FIDIAS		ONICE
152	FREEZE		ZAR
156	GIOIA	268	PERSEPOLIS
162	HETTANGIAN FLOOR	274	PETRA
170	KRITIOS	280	LUXURY
176	MADISON	284	LED
182	METROPOLITAN FLOOR	288	CONCEPT
188	ORIO	294	BANSKY



↓
8 mm — 0,31"
↑

100 x 180 x 0,8 cm
39,2 x 70,8 x 0,31 "

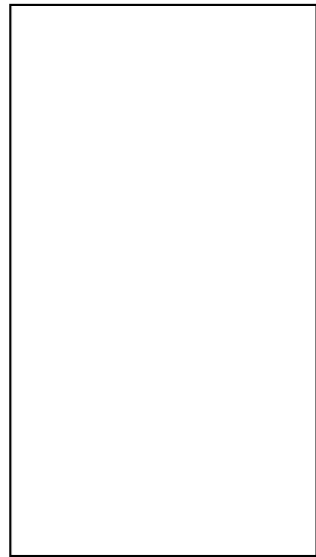

100 x 100 x 0,8 cm
39,2 x 39,3 x 0,31 "

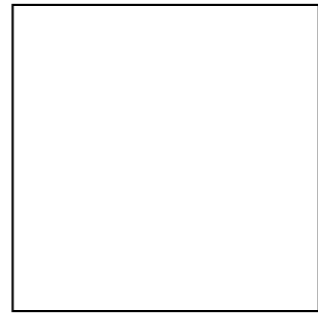

50 x 100 x 0,8 cm
19,6 x 39,3 x 0,31 "

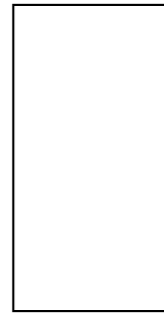

19,5 x 150 cm
7,6 x 59 "



75,5x151 cm
29,7x59,4"

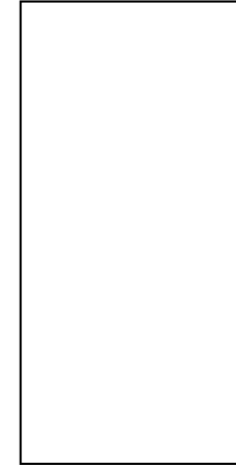

90x90 cm
35,4x35,4"

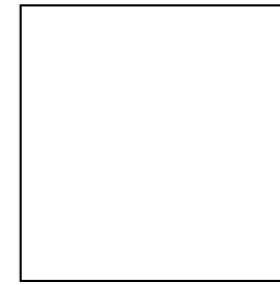

60x60 cm
23,6x23,6"

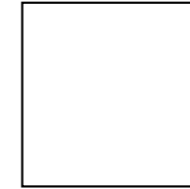

44x44 cm
17,3x17,3"



60x120 cm
23,6x47,2"

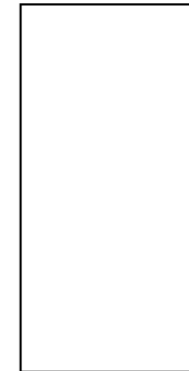

19,5x120 cm
7,6x47,2 "



45x90 cm
17,7x35,4"

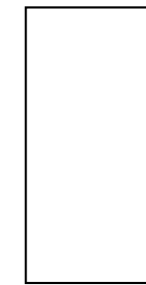

30x60 cm
11,8x23,6"

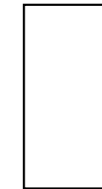

FINISHED

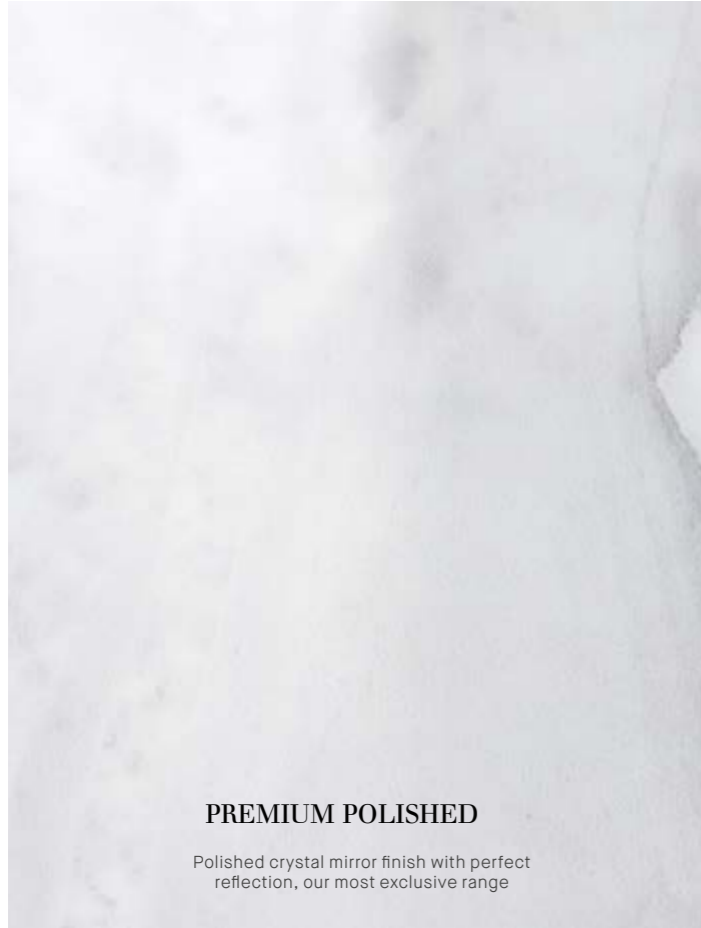

PREMIUM POLISHED

Polished crystal mirror finish with perfect reflection, our most exclusive range

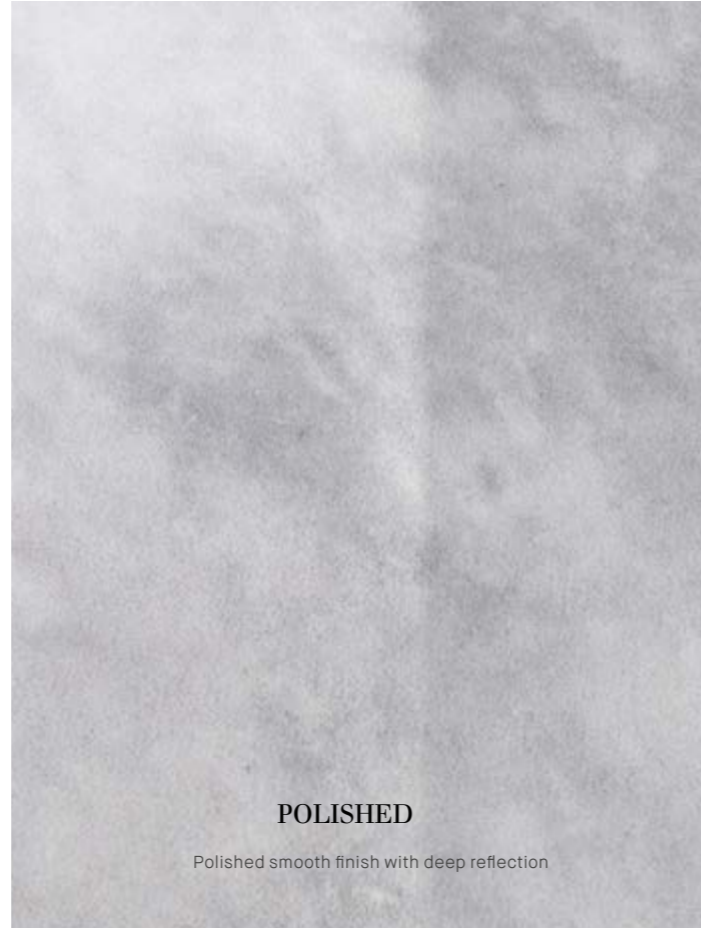

POLISHED

Polished smooth finish with deep reflection



RIVER-WASHED

Subtle and organic, replicating the original texture of natural stone

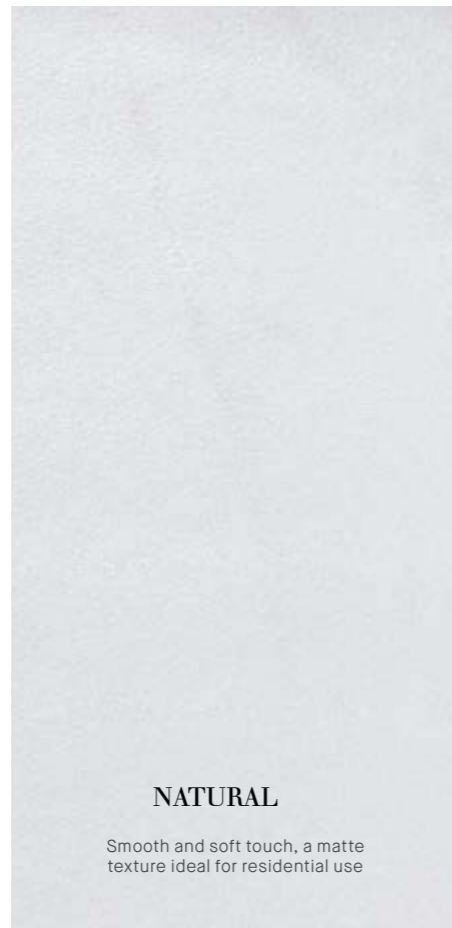

NATURAL

Smooth and soft touch, a matte texture ideal for residential use











FLAMED

Rough and irregular, ideal texture for exterior applications

TESTS

Essay	Features	Result				
		PREMIUM POLISHED (P)	POLISHED (EP)	NATURAL (NAT)	RIVER-WASHED (RW)	FLAMED (FLAM)
DIN 51130	Critical angle (Inclined platform)	—	—	—	R9	R11
UNE-ENV 12633	Slip resistance (Pendulum test)	—	—	Class 1	Class 1	Class 3
BS 7976-2	Slip resistance (Pendulum test - PTV)	—	—	—	+36 Wet	+36 Wet
ANSI A137.1	Dynamic Coefficient of Friction (DCOF)	—	—	>0,42 Wet	>0,42 Wet	>0,42 Wet

TECHNICAL CHARACTERISTICS

	 JOINT	 FROST PROOF	 VERSATILE	 RECTIFIED	 DIFERENT SHADES	 SHADE VARIATION	 VARIOUS GRAPHICS	 CLEANING NON-ABRASIVE
PREMIUM POLISHED (P)	✓	✓	✓	✓	✓	✓	✓	✓
POLISHED (EP)	✓	✓	✓	✓	✓	✓	✓	✓
NATURAL (NAT)	✓	✓	✓	✓	✓	✓	✓	✓
RIVER-WASHED (RW)	✓	✓	✓	✓	✓	✓	✓	✓
FLAMED (FLAM)	✓	✓	✓	✓	✓	✓	✓	✓

APPLICATIONS

Area	Wall					Floor				
	P	EP	NAT	RW	FLAM	P	EP	NAT	RW	FLAM
Interior	yes	yes	yes	yes	yes	yes	yes	yes	yes	yes
Exterior	yes	yes	yes	yes	yes	yes	yes	yes	yes	yes
Traffic	yes	yes	yes	yes	yes	light	light	light	medium	high
Wet areas	yes	yes	yes	yes	yes	no	no	no	no	yes

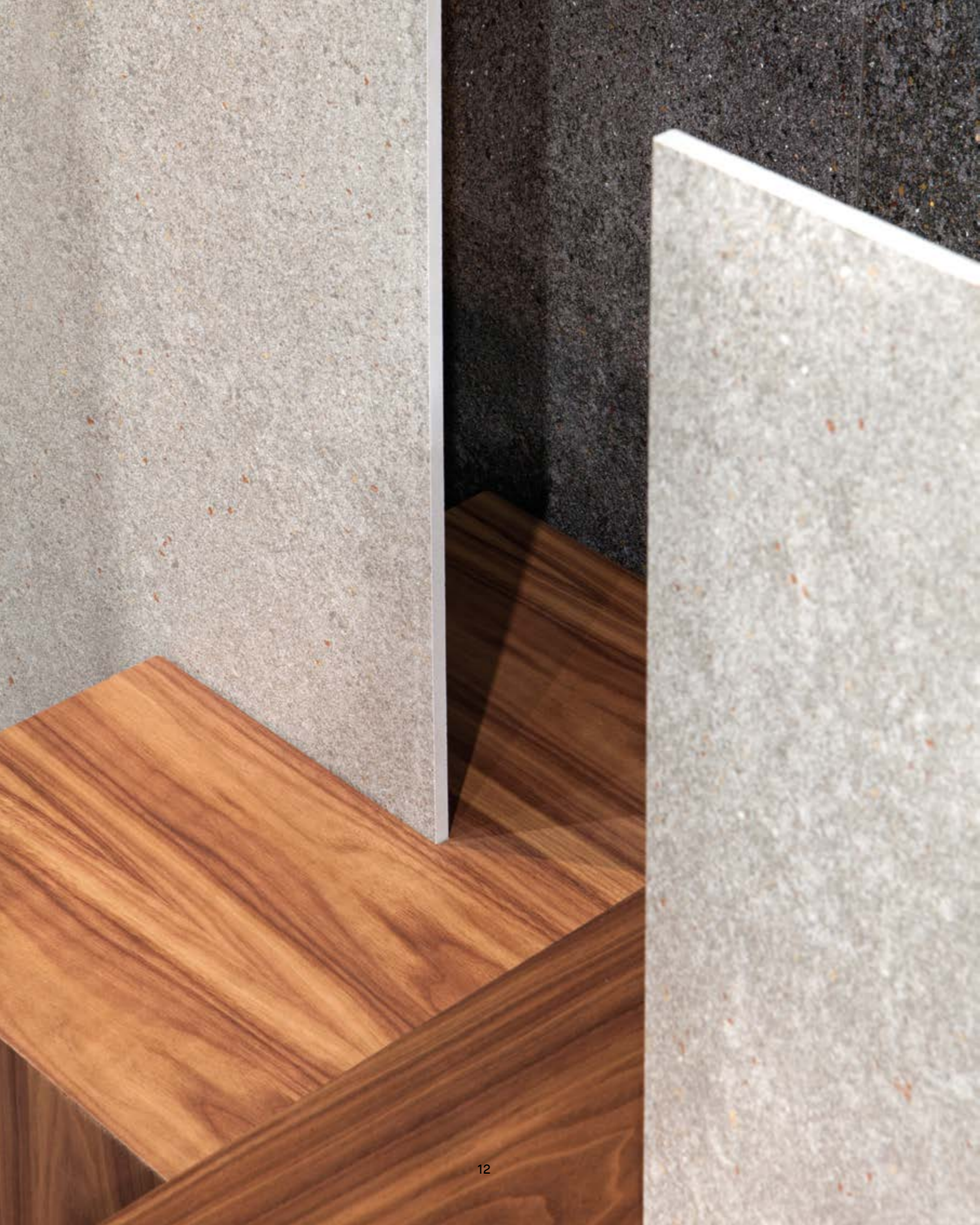

BREAKING THE BOUNDARIES OF EXCELLENCE

4D TECH is the most innovative tile manufacturing system on the market, based on exclusive new technology aimed at guaranteeing quality second to none.

THE NEW MUSEUM RANGE

Thanks to the use of new 4D TECH technology, Museum has broken its own record for excellence, achieving a level of precision and versatility that no other tile range can equal.

DIMENSIONS

Even more formats

New more varied formats. With 4DTECH technology, there are no limits to the formats that can be produced and so there are no limits to the settings where our exclusive products can be used.

DESIGN

Limitless creativity

Collections developed with 4TECH and its improved technology break new ground in design, thanks to its new aesthetic and material-related potential for creating products that are simply unique.

DEFINITION

Simply amazing detail







Opening up new ground in precision and tile finishes. Thanks to our new production system, not only can we improve on real sources of inspiration but we can also reinvent nature through products like nothing you will have ever seen.

DISTINCTION

Committed to innovation

With the arrival of new 4DTECH technology, Museum has yet again demonstrated that it is a trailblazer in the introduction of technological innovations, guaranteeing consumers exclusive products that are a cut above all the rest.







www.museumsurfaces4d.com

Pág.						
	100x180 cm 29,7x59,4"	100x100 cm 29,7x59,4"	50x100 cm 29,7x59,4"	19,5x150 cm 29,7x59,4"	75,5x151 cm 29,7x59,4"	90x90 cm 35,4x35,4"

AGATHA	246					
BANSKY	294					
BARDIGLIO	62				EP RW	
BASATI	105				EP NAT	
CALACATTA 4D	16	EP NAT				
CAPITAL	252					
CONCEPT	288					
DEEP 4D	20	EP NAT				
ETERNAL 4D	26	EP NAT				
FIDIAS	146					EP
FREEZE	152					EP
GIOIA	156					EP
GREVIN	208					
GREYSTONE	74				EP NAT	EP NAT
HETTANGIAN FLOOR	162					EP
KRITIOS	170					EP
LED	284					EP
LENS	212					
LUMINA	222					
LUXURY	280					
MACBA - MUVIM	256					
MADISON	176					EP
MARQ	226					
MARQUINA	83				EP NAT	EP NAT
MENHIR	230					
METROPOLITAN FLOOR	182					EP
NARA	110				EP NAT	
ONIX	118				EP	
OPALO, BACH, ONICE, ZAR	262					
ORIO	188					EP
PERSEPOLIS	268					
PETRA	274					
RUGBY 4D	32	EP NAT			EP NAT	
SANTANA	124				EP	
SHERWOOD OAK 4D	54				NAT	
SOLTO	42	EP NAT			EP NAT	
STATE	192					EP
STATUARIO PLUS	92				EP NAT	EP NAT
STIAVA	196					EP
SUITE	128				EP	
SUNSHINE	202					EP
TORANO	138				EP NAT	EP NAT
TUCCI	234					
VOGUE	242					

FINISH

EP — POLISHED
P — PREMIUM POLISHED
NAT — NATURAL
RW — NATURAL RIVERWASHED
F — FLAMED

					
45x90 cm 17,7x35,4"	60x120 cm 23,6x47,2"	19,5x120 cm 23,6x47,2"	60x60 cm 23,6x23,6"	30x60 cm 11,8x23,6"	44x44 cm 17,3x17,3"

						246	AGATHA	
							294	BANSKY
							62	BARDIGLIO
							105	BASATI
							16	CALACATTA 4D
							252	CAPITAL
							288	CONCEPT
							20	DEEP 4D
							26	ETERNAL 4D
							146	FIDIAS
							152	FREEZE
							156	GIOIA
							208	GREVIN
							74	GREYSTONE
							162	HETTANGIAN FLOOR
							170	KRITIOS
							284	LED
							212	LENS
							222	LUMINA
							280	LUXURY
							256	MACBA - MUVIM
							176	MADISON
							226	MARQ
							83	MARQUINA
							230	MENHIR
							182	METROPOLITAN FLOOR
							110	NARA
							118	ONIX
							262	OPALO, BACH, ONICE, ZAR
							188	ORIO
							268	PERSEPOLIS
							274	PETRA
							32	RUGBY 4D
							124	SANTANA
							54	SHERWOOD OAK 4D
							42	SOLTO
							192	STATE
							92	STATUARIO PLUS
							196	STIAVA
							128	SUITE
							202	SUNSHINE
							138	TORANO
							234	TUCCI
							242	VOGUE



Calacatta 4D



Calacatta 4D — Extra white

4^{TECH} 8 mm - 0,31"
THICKNESS

Colors / Colores



Extra white

Finished / Acabados



polished



natural

Dimensions / Dimensiones

100 × 180 cm
39,3 × 70,8"

100 × 100 cm
39,3 × 39,3"

20 patterns

20 patterns

Shade variation: V3

Thickness: 8 mm / 0,31"

References / Referencias

Price code

24203 CALACATTA EXTRA WHITE/100X180/EP	M76
23211 CALACATTA EXTRA WHITE/100X180/NAT/R	M75
24206 CALACATTA EXTRA WHITE/100X100/EP	M76
23977 CALACATTA EXTRA WHITE/100X100/NAT/R	M75



Deep 4D



8 mm - 0,31"
THICKNESS

Deep 4D



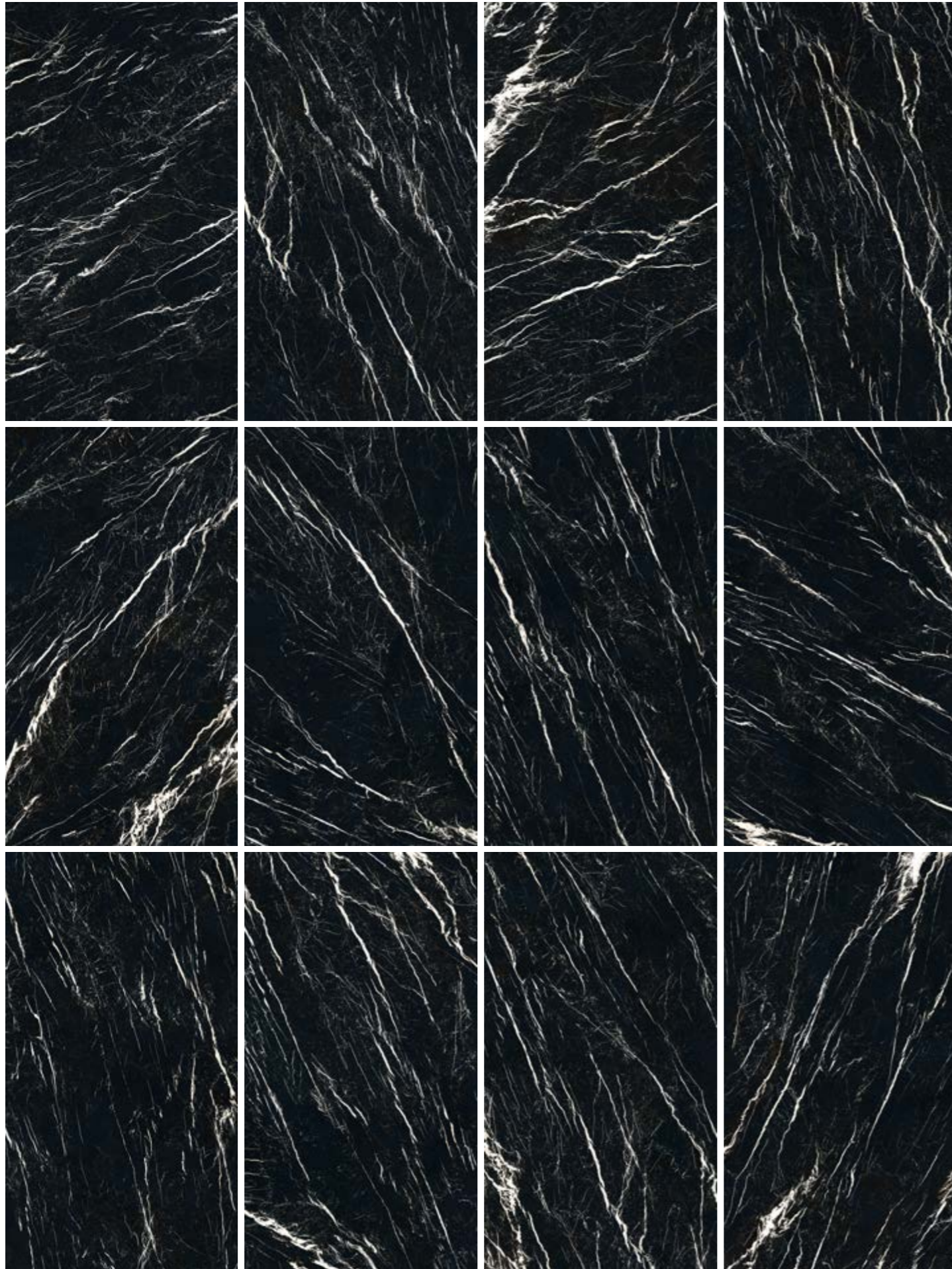

Deep — Black

4
TECH 8 mm - 0,31"
THICKNESS

Colors / Colores

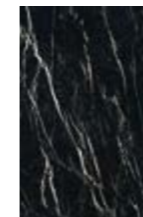

Black

Finished / Acabados



polished

natural

Dimensions / Dimensiones

100 × 180 cm
39,3 × 70,8"

100 × 100 cm
39,3 × 39,3"

12 patterns

12 patterns
Shade variation: V3
Thickness: 8 mm / 0,31"

References / Referencias

Price code

24201 DEEP BLACK/100X180/EP	M76
23973 DEEP BLACK/100X180/NAT/R	M75
24205 DEEP BLACK/100X100/EP	M76
23975 DEEP BLACK/100X100/NAT/R	M75



Eternal 4D





Eternal — White

4
TECH 8 mm - 0,31"
THICKNESS

Colors / Colores



white

Finished / Acabados



polished



natural

Dimensions / Dimensiones

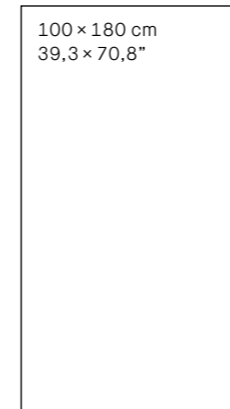

15 patterns
Shade variation: V3
Thickness: 8 mm / 0,31"

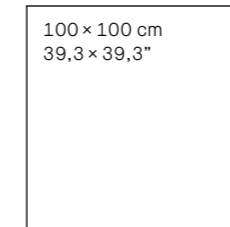

15 patterns

References / Referencias

Price code

24202 ETERNAL WHITE/100X180/EP	M76
23970 ETERNAL WHITE/100X180/NAT/R	M75
24204 ETERNAL WHITE/100X100/EP	M76
23976 ETERNAL WHITE/100X100/NAT/R	M75



Rugby 4D



8 mm - 0,31"
THICKNESS

Rugby 4D







8 mm - 0,31"
THICKNESS

Rugby 4D

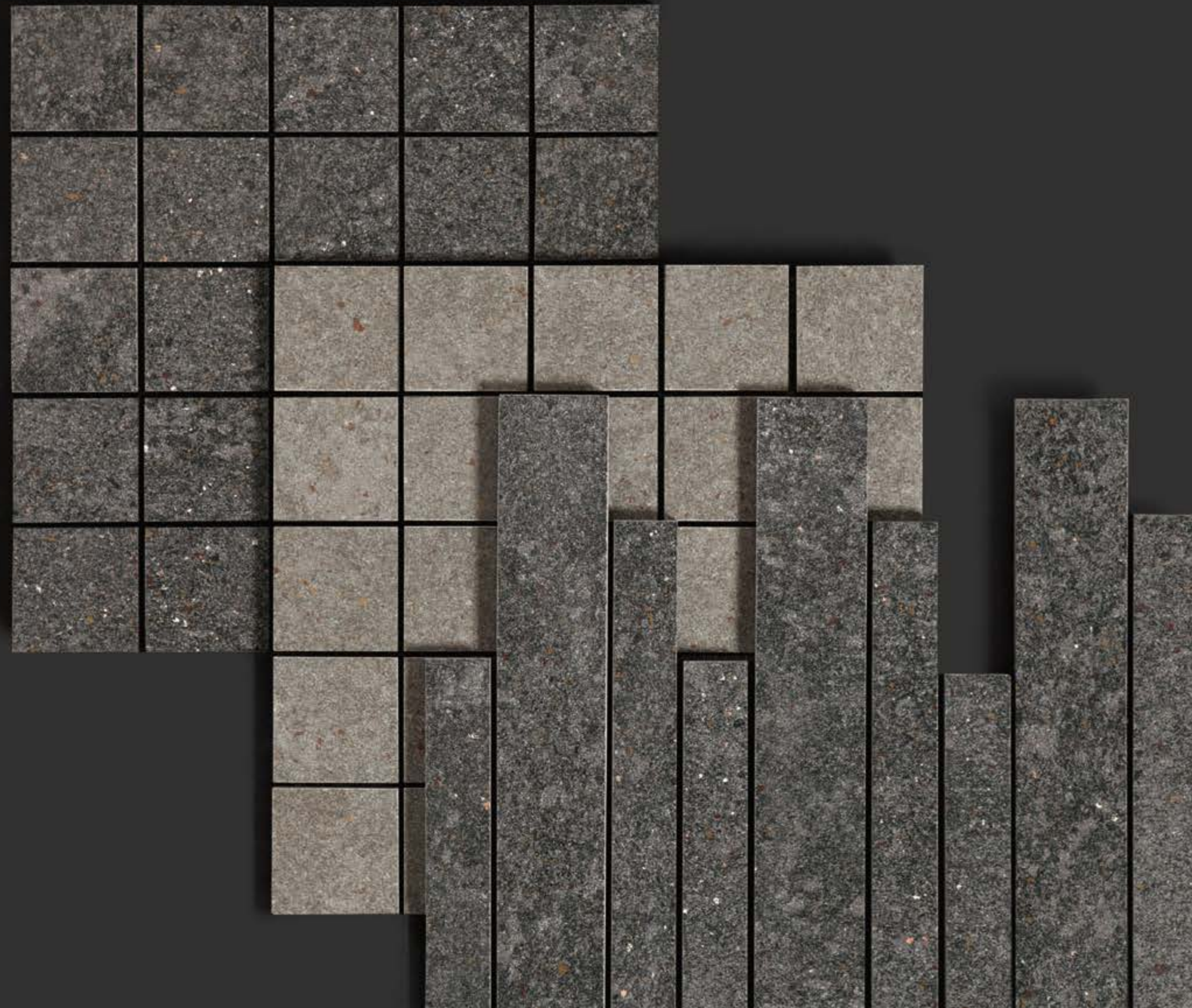



Rugby — Black

4
TECH 8 mm - 0,31"
THICKNESS

Colors / Colores



black Grey

Finished / Acabados



polished natural

Dimensions / Dimensiones

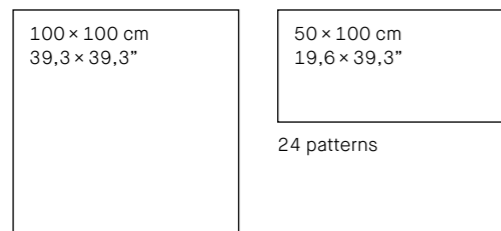

12 patterns
Shade variation: V2
Thickness: 8 mm / 0,31"

References / Referencias

References / Referencias	Price code
23432 RUGBY BLACK/100X100/EP	M70
23446 RUGBY BLACK/100X100/NAT/R	M69
23434 RUGBY BLACK/50X100/NAT/R	M69
23431 RUGBY GREY/100X100/EP	M70
23445 RUGBY GREY/100X100/NAT/R	M69
23433 RUGBY GREY/50X100/NAT/R	M69

Rugby — Grey

4
TECH 8 mm - 0,31"
THICKNESS

Decorados / Decors

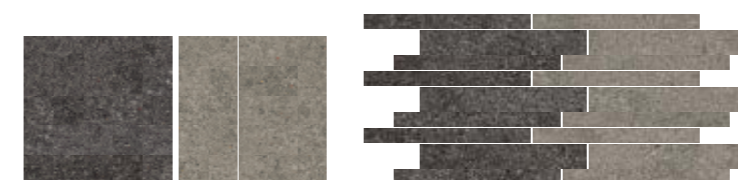

black Grey black Grey

Dimensions / Dimensiones

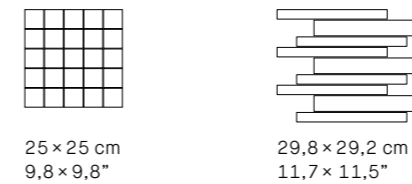

25 x 25 cm
9,8 x 9,8"

29,8 x 29,2 cm
11,7 x 11,5"

References / Referencias

References / Referencias	Price code
23550 D. RUGBY BLACK MOSAIC/25X25/EP	U44
23551 D. RUGBY BLACK MOSAIC/25X25/NAT	U39
23554 D. RUGBY BLACK BRICK/29,8X29,2/EP	U51
23555 D. RUGBY BLACK BRICK/29,8X29,2/NAT	U50
23549 D. RUGBY GREY MOSAIC/25X25/EP	U44
23552 D. RUGBY GREY MOSAIC/25X25/NAT	U39
23553 D. RUGBY GREY BRICK/29,8X29,2/EP	U51
23556 D. RUGBY GREY BRICK/29,8X29,2/NAT	U50



Solto



8 mm - 0,31"
THICKNESS

Solto





8 mm - 0,31"
THICKNESS

Solto





8 mm - 0,31"
THICKNESS

Solto





8 mm - 0,31"
THICKNESS

Solto

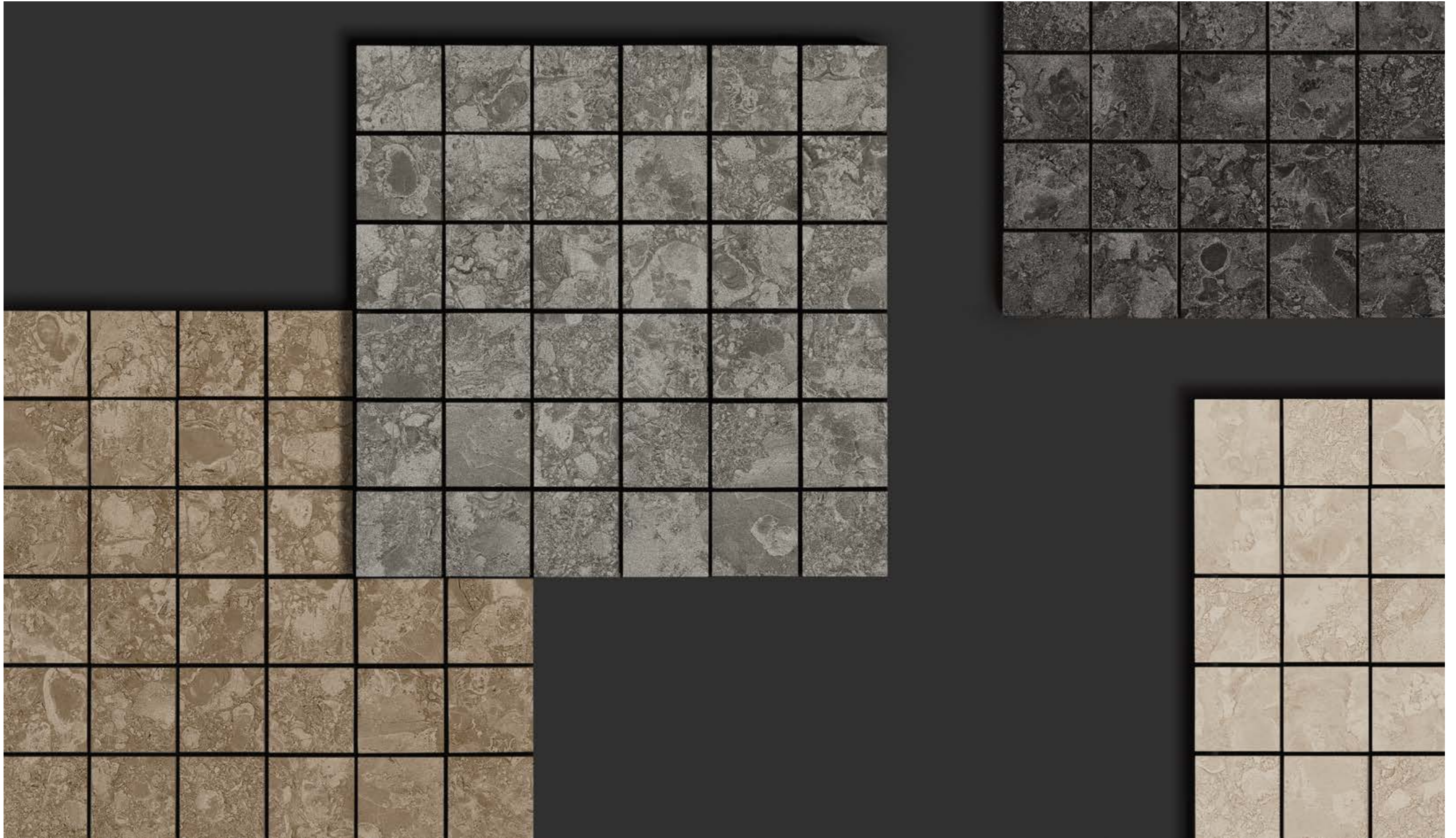

D. SOLTO TAUPE MOSAIC/25X25/RW — D. SOLTO SAND MOSAIC/25X25/RW
D. SOLTO BLACK MOSAIC/25X25/RW — D. SOLTO GREY MOSAIC/25X25/RW



Solto

4
TECH 8 mm - 0,31"
THICKNESS

Solto

4
TECH 8 mm - 0,31"
THICKNESS

Colors / Colores

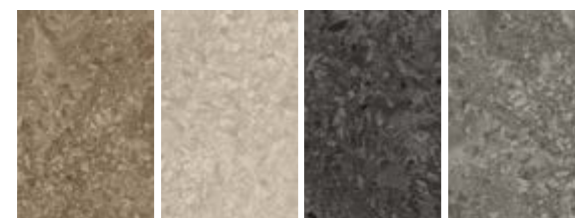

Taupe Sand Black Grey

Finished / Acabados

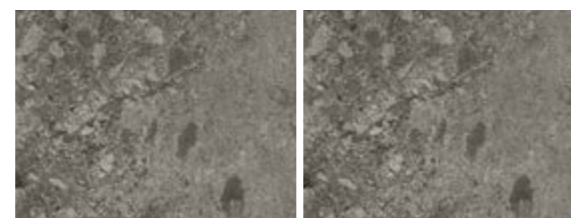

polished river-washed

Decorados / Decors

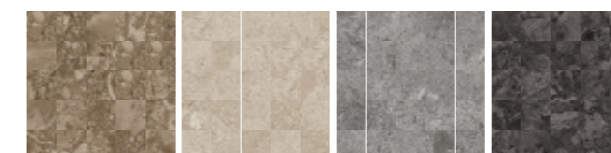

Taupe Sand Black Grey

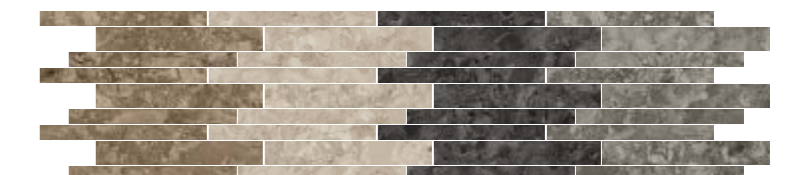

Taupe Sand Black Grey

Dimensions / Dimensiones

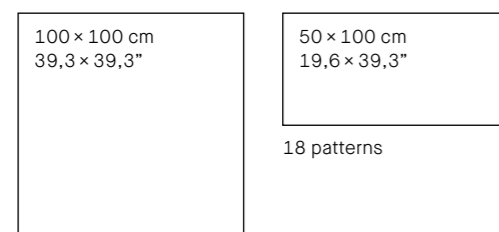

18 patterns

9 patterns
Shade variation: V2
Thickness: 8 mm / 0,31"

References / Referencias

References / Referencias	Price code
22307 SOLTO TAUPE/100X100/EP	M70
22209 SOLTO TAUPE/100X100/RW/R	M69
22214 SOLTO TAUPE/50X100/RW/R	M69
22306 SOLTO SAND/100X100/EP	M70
22208 SOLTO SAND/100X100/RW/R	M69
22213 SOLTO SAND/50X100/RW/R	M69
22309 SOLTO GREY/100X100/EP	M70
22210 SOLTO GREY/100X100/RW/R	M69
22215 SOLTO GREY/50X100/RW/R	M69
22308 SOLTO BLACK/100X100/EP	M70
22211 SOLTO BLACK/100X100/RW/R	M69
22212 SOLTO BLACK/50X100/RW/R	M69

Dimensions / Dimensiones

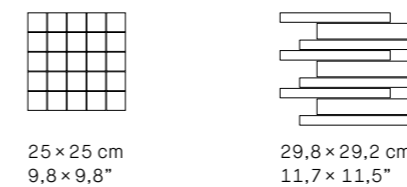

25 x 25 cm
9,8 x 9,8"

29,8 x 29,2 cm
11,7 x 11,5"

References / Referencias

References / Referencias	Price code
22745 D. SOLTO TAUPE MOSAIC/25X25/EP	U44
22749 D. SOLTO TAUPE MOSAIC/25X25/RW	U39
22753 D. SOLTO TAUPE BRICK/29,8X29,2/EP	U51
22757 D. SOLTO TAUPE BRICK/29,8X29,2/RW	U50
22743 D. SOLTO SAND MOSAIC/25X25/EP	U44
22748 D. SOLTO SAND MOSAIC/25X25/RW	U39
22752 D. SOLTO SAND BRICK/29,8X29,2/EP	U51
22756 D. SOLTO SAND BRICK/29,8X29,2/RW	U50
22747 D. SOLTO BLACK MOSAIC/25X25/EP	U44
22751 D. SOLTO BLACK MOSAIC/25X25/RW	U39
22755 D. SOLTO BLACK BRICK/29,8X29,2/EP	U44
22759 D. SOLTO BLACK BRICK/29,8X29,2/RW	U50
22746 D. SOLTO GREY MOSAIC/25X25/EP	U44
22750 D. SOLTO GREY MOSAIC/25X25/RW	U39
22754 D. SOLTO GREY BRICK/29,8X29,2/EP	U44
22758 D. SOLTO GREY BRICK/29,8X29,2/RW	U39



Sherwood oak 4D



8 mm - 0,31"
THICKNESS

Sherwood oak 4D





8 mm - 0,31"
THICKNESS



Sherwood oak 4D





Sherwood

4
TECH 8 mm - 0,31"
THICKNESS

Colors / Colores



Honey Cognac Porto Kalua Ebony

Finished / Acabados

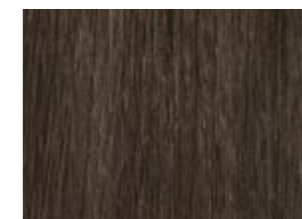

natural

Dimensions / Dimensiones

19,5 × 150 cm - 7,6 × 59"

50 patterns

Shade variation: V3

Thickness: 8 mm / 0,31"

References / Referencias

References / Referencias	Price code
23629 SHERWOOD HONEY/19,5X150/NAT/R	M71
23609 SHERWOOD COGNAC/ 19,5X150/NAT/R	M71
23454 SHERWOOD PORTO/19,5X150/NAT/R	M71
23630 SHERWOOD KALUA/19,5X150/NAT/R	M71
23611 SHERWOOD EBONY/19,5X150/NAT/R	M71



Bardiglio







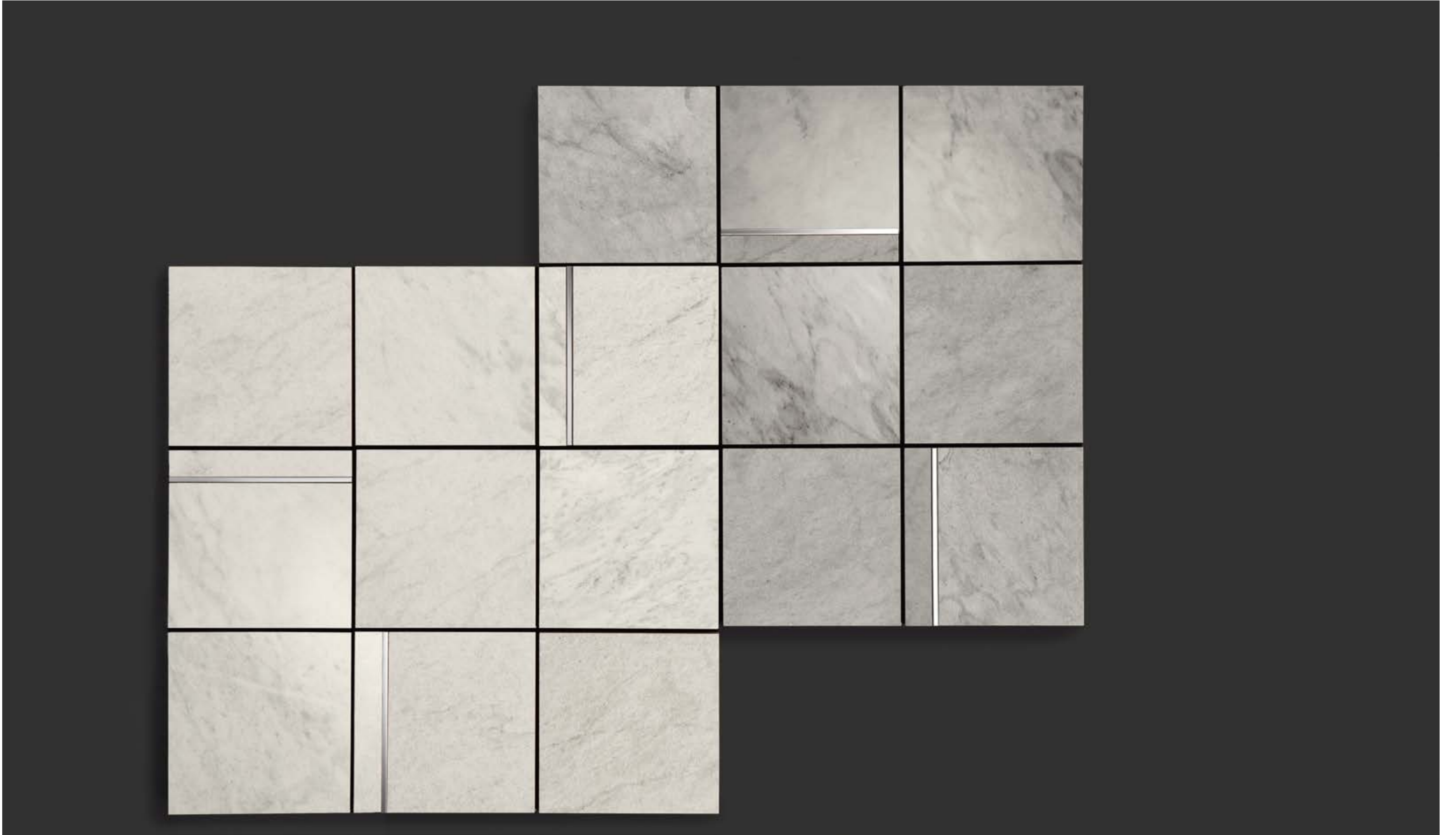



Bardiglio — Pearl

Colors / Colores

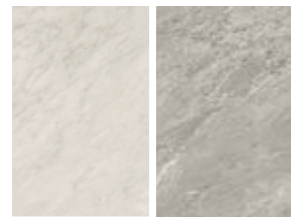

Pearl

Grey

Finished / Acabados



polished

river-washed

Flam

Dimensions / Dimensiones

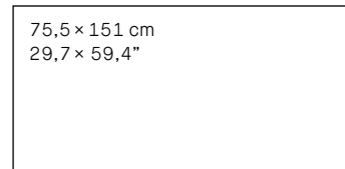

75,5 × 151 cm
29,7 × 59,4"

40 patterns

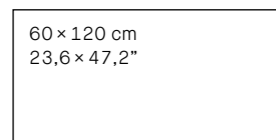

60 × 120 cm
23,6 × 47,2"

40 patterns

Shade variation: V2

References / Referencias

References / Referencias	Price code
21067 BARDIGLIO PEARL/75,5x151/EP	M58
21073 BARDIGLIO PEARL/75,5x151/RW/R	M59
22060 BARDIGLIO PEARL/60x120/EP	M40
22115 BARDIGLIO PEARL/60x120/FLAM/R	M66
22112 BARDIGLIO PEARL/60x120/RW/R	M66
21066 BARDIGLIO GREY/75,5x151/EP	M58
21072 BARDIGLIO GREY/75,5x151/RW/R	M59
22059 BARDIGLIO GREY/60x120/EP	M40
22114 BARDIGLIO GREY/60x120/FLAM/R	M66
22113 BARDIGLIO GREY/60x120/RW/R	M66



Bardiglio — Grey

Decorados / Decors



Pearl

Grey

Dimensions / Dimensiones

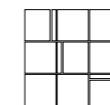

30 × 30 cm
11,8 × 11,8"

mixed finishes
polished | river-washed

References / Referencias

References / Referencias	Price code
22250 D. BARDIGLIO PEARL MOSAIC/30X30	U58
22249 D. BARDIGLIO GREY MOSAIC/30X30	U58

22302 L.ALUMINUM/120/MATT U44 (0,5x120 cm - 0,19x47,2 ")

22314 L.ALUMINUM/120/SHINE U44 (0,5x120 cm - 0,19x47,2 ")



Greystone



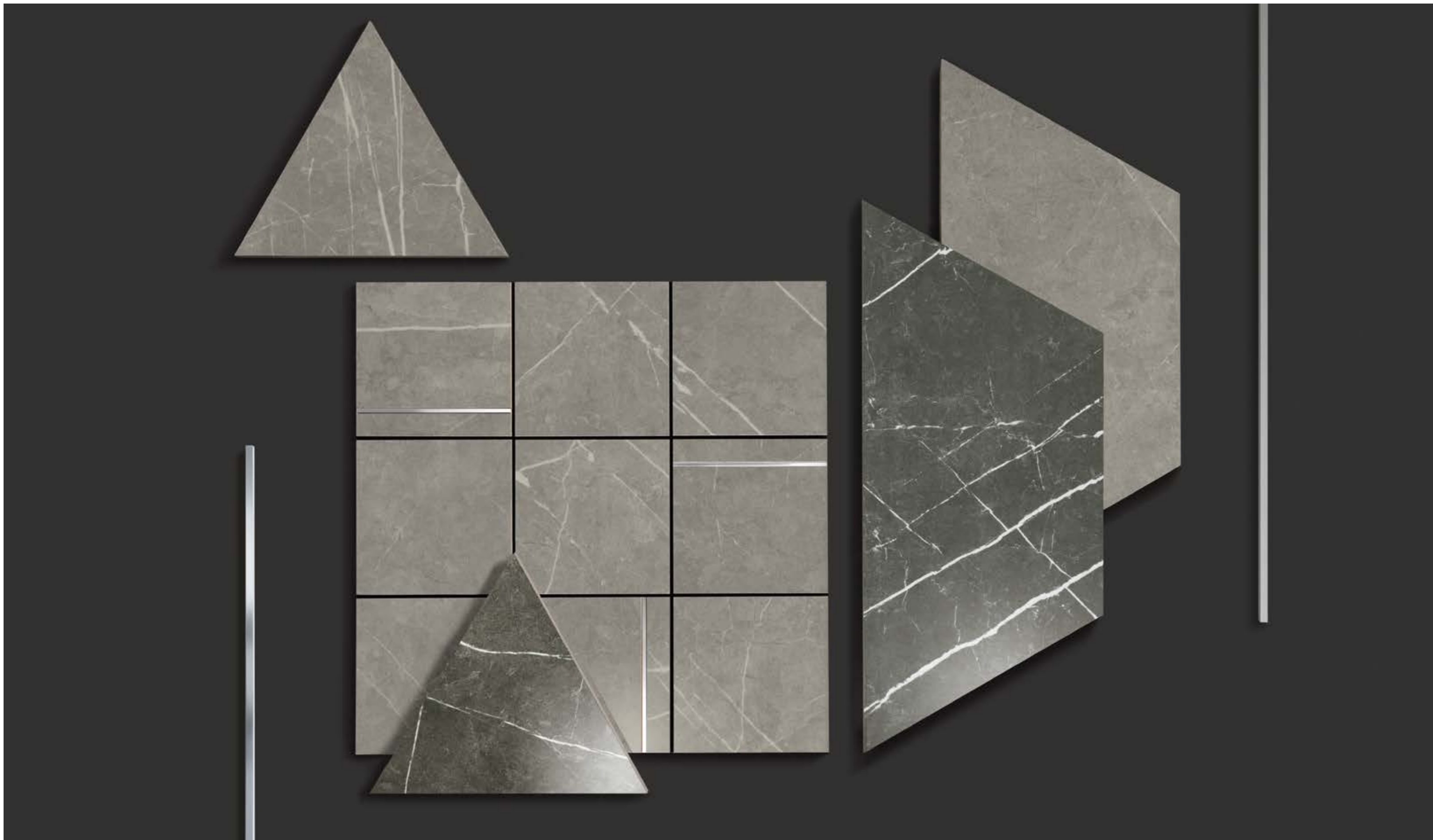

D. GREYSTONE ARGEN MOSAIC/30X30/EP — TRAP. GREYSTONE ARGENT/34,5X15/NAT
TRAP. GREYSTONE SMOKE/34,5X15/NAT — TRI. GREYSTONE ARGENT/17,2X15/NAT
TRI. GREYSTONE SMOKE/17,2X15/NAT



Greystone— Argent

Greystone— Smoke

Colors / Colores

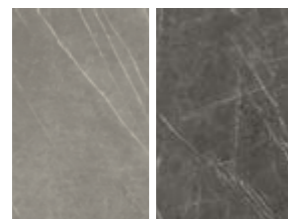

Argent

Smoke

Finished / Acabados

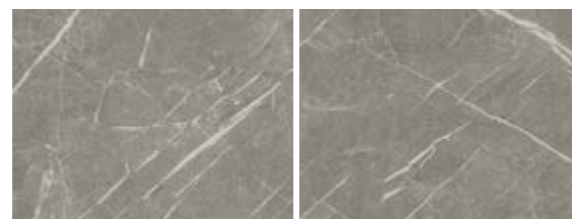

polished

natural

Decorados / Decors

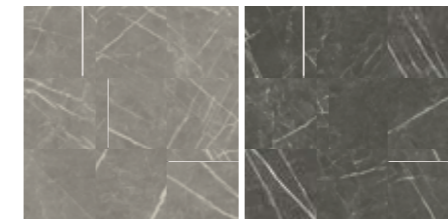

Argent

Smoke



Argent

Smoke



Argent

Smoke



greystone—marquina
statuario plus

Dimensions / Dimensiones

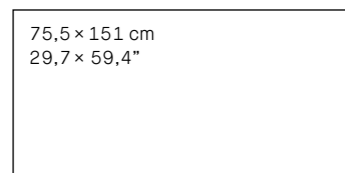

75,5 × 151 cm
29,7 × 59,4"

12 patterns

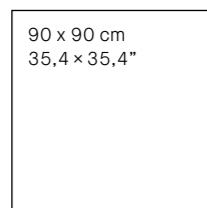

90 × 90 cm
35,4 × 35,4"

12 patterns

Shade variation: V2

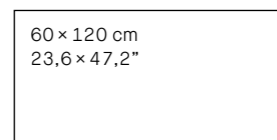

60 × 120 cm
23,6 × 47,2"

15 patterns

References / Referencias

References / Referencias	Price code
23447 GREYSTONE ARGENT/75,5x151/EP	M58
23475 GREYSTONE ARGENT/75,5x151/NAT/R	M59
23459 GREYSTONE ARGENT/60x120/EP	M40
23469 GREYSTONE ARGENT/60x120/NAT/R	M66
23295 GREYSTONE ARGENT/90x90/EP	M2
23478 GREYSTONE ARGENT/90x90/NAT/R	M68
23448 GREYSTONE SMOKE/75,5x151/EP	M58
23474 GREYSTONE SMOKE/75,5x151/NAT/R	M59
23460 GREYSTONE SMOKE/60x120/EP	M40
23470 GREYSTONE SMOKE/60x120/NAT/R	M66
23296 GREYSTONE SMOKE/90x90/EP	M2
23477 GREYSTONE SMOKE/90x90/NAT/R	M68

Dimensions / Dimensiones

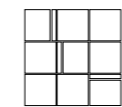

30 × 30 cm
11,8 × 11,8"

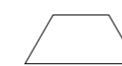

34,5 × 15 cm
13,6 × 5,9"

mixed
finishes
polished | natural



16 × 25 cm
6,3 × 9,8"



17,2 × 15 cm
6,7 × 5,9"

greystone
marquina
statuario plus

References / Referencias

References / Referencias	Price code
23539 D. GREYSTONE ARGEN MOSAIC/30X30/EP	U58
23540 D. GREYSTONE SMOKE MOSAIC/30X30/EP	U58
23558 TRAP. GREYSTONE ARGENT/34,5x15/EP	U28
23683 TRAP. GREYSTONE ARGENT/34,5x15/NAT	U28
23562 TRAP. GREYSTONE SMOKE/34,5x15/EP	U28
23684 TRAP. GREYSTONE SMOKE/34,5x15/NAT	U28
23557 TRI. GREYSTONE ARGENT/17,2x15/EP	U13
23687 TRI. GREYSTONE ARGENT/17,2x15/NAT	U13
23559 TRI. GREYSTONE SMOKE/17,2x15/EP	U13
23688 TRI. GREYSTONE SMOKE/17,2x15/NAT	U13
23537 D. STONE MIX ARR./16X25/EP	U49

22302 L.ALUMINUM/120/MATT U44 (0,5x120 cm - 0,19x47,2 ")



22314 L.ALUMINUM/120/SHINE U44 (0,5x120 cm - 0,19x47,2 ")





Marquina







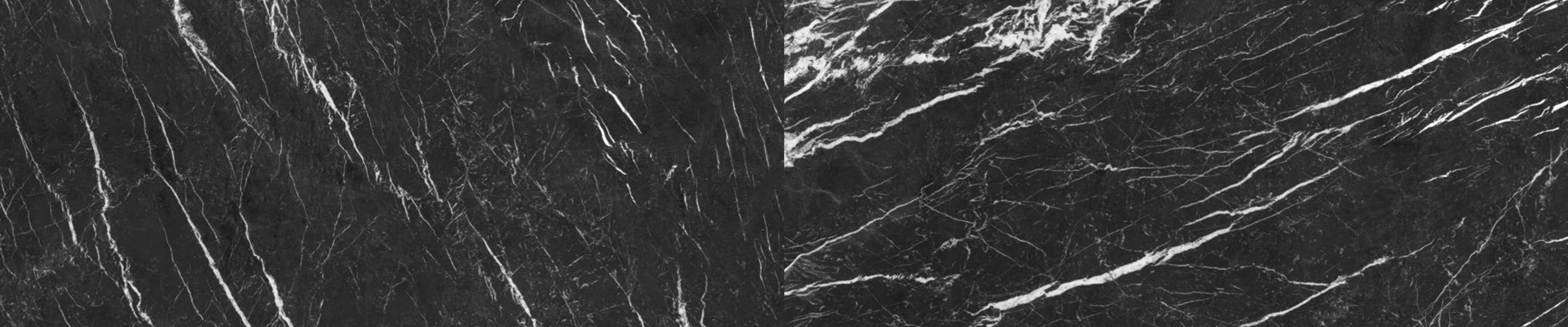

Marquina — Black

Marquina — Black

Colors / Colores

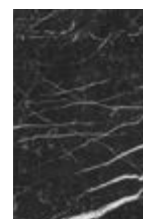

Black

Finished / Acabados

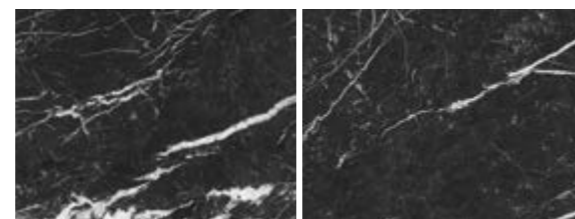

polished

natural

Decorados / Decors

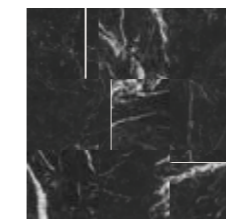

Black

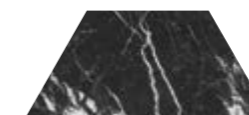

Black

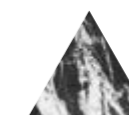

Black



greystone—marquina
statuario plus

Dimensions / Dimensiones

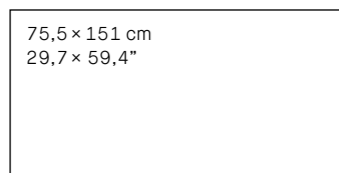

75,5 × 151 cm
29,7 × 59,4"

12 patterns

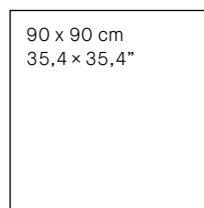

90 × 90 cm
35,4 × 35,4"

12 patterns

Shade variation: V2

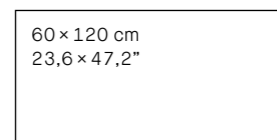

60 × 120 cm
23,6 × 47,2"

15 patterns

References / Referencias

References / Referencias	Price code
23453 MARQUINA BLACK/75,5x151/EP	M74
23473 MARQUINA BLACK/75,5x151/NAT/R	M59
23461 MARQUINA BLACK/60x120/EP	M73
23471 MARQUINA BLACK/60x120/NAT/R	M66
23297 MARQUINA BLACK/90x90/EP	M72
23479 MARQUINA BLACK/90x90/NAT/R	M68

Dimensions / Dimensiones

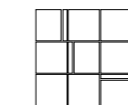

30 × 30 cm
11,8 × 11,8"

mixed
finishes
polished | natural



34,5 × 15 cm
13,6 × 5,9"



16 × 25 cm
6,3 × 9,8"



17,2 × 15 cm
6,7 × 5,9"

greystone
marquina
statuario plus

References / Referencias

References / Referencias	Price code
23542 D. MARQUINA BLACK MOSAIC/30X30/EP	U58
23560 TRI. MARQUINA BLACK/17,2x15/EP	U13
23689 TRI. MARQUINA BLACK/17,2x15/NAT	U13
23563 TRAP. MARQUINA BLACK/34,5x15/EP	U28
23686 TRAP. MARQUINA BLACK/34,5x15/NAT	U28
23537 D. STONE MIX ARR./16X25/EP	U49

22302 L.ALUMINUM/120/MATT U44 (0,5x120 cm - 0,19x47,2 ")



22314 L.ALUMINUM/120/SHINE U44 (0,5x120 cm - 0,19x47,2 ")





Statuario Plus





D. STATUARIO PLUS MOSAIC/30X30/EP — TRI. STATUARIO PLUS/17,2x15/NAT
TRAP. STATUARIO PLUS/34,5x15/NAT — D. STONE MIX ARR./16X25/EP



Statuario Plus

Colors / Colores



Finished / Acabados



polished

natural

Statuario Plus

Decorados / Decors



greystone—marquina
statuario plus

Dimensions / Dimensiones

75,5 x 151 cm
29,7 x 59,4"

15 patterns

90 x 90 cm
35,4 x 35,4"

60 x 120 cm
23,6 x 47,2"

16 patterns

12 patterns

Shade variation: V2

References / Referencias

References / Referencias	Price code
23463 STATUARIO PLUS/75,5x151/EP	M58
23476 STATUARIO PLUS/75,5x151/NAT/R	M59
23462 STATUARIO PLUS/60x120/EP	M40
23472 STATUARIO PLUS/60x120/NAT/R	M66
23298 STATUARIO PLUS/90x90/EP	M2
23480 STATUARIO PLUS/90x90/NAT/R	M68

Dimensions / Dimensiones

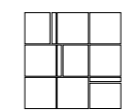

30 x 30 cm
11,8 x 11,8"

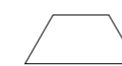

34,5 x 15 cm
13,6 x 5,9"



16 x 25 cm
6,3 x 9,8"



17,2 x 15 cm
6,7 x 5,9"

mixed
finishes
polished | natural

greystone
marquina
statuario plus

References / Referencias

References / Referencias	Price code
23541 D. STATUARIO PLUS MOSAIC/30X30/EP	U58
23561 TRI. STATUARIO PLUS/17,2x15/EP	U13
23690 TRI. STATUARIO PLUS/17,2x15/NAT	U13
23564 TRAP. STATUARIO PLUS/34,5x15/EP	U28
23685 TRAP. STATUARIO PLUS/34,5x15/NAT	U28
23537 D. STONE MIX ARR./16X25/EP	U49

22302 L.ALUMINUM/120/MATT U44 (0,5x120 cm - 0,19x47,2 ")

22314 L.ALUMINUM/120/SHINE U44 (0,5x120 cm - 0,19x47,2 ")



TRAP. GREYSTONE ARGENT/34,5X15/NAT — TRAP. GREYSTONE SMOKE/34,5X15/NAT
TRAP. MARQUINA BLACK/34,5X15/NAT — TRAP. STATUARIO PLUS/34,5X15/EP

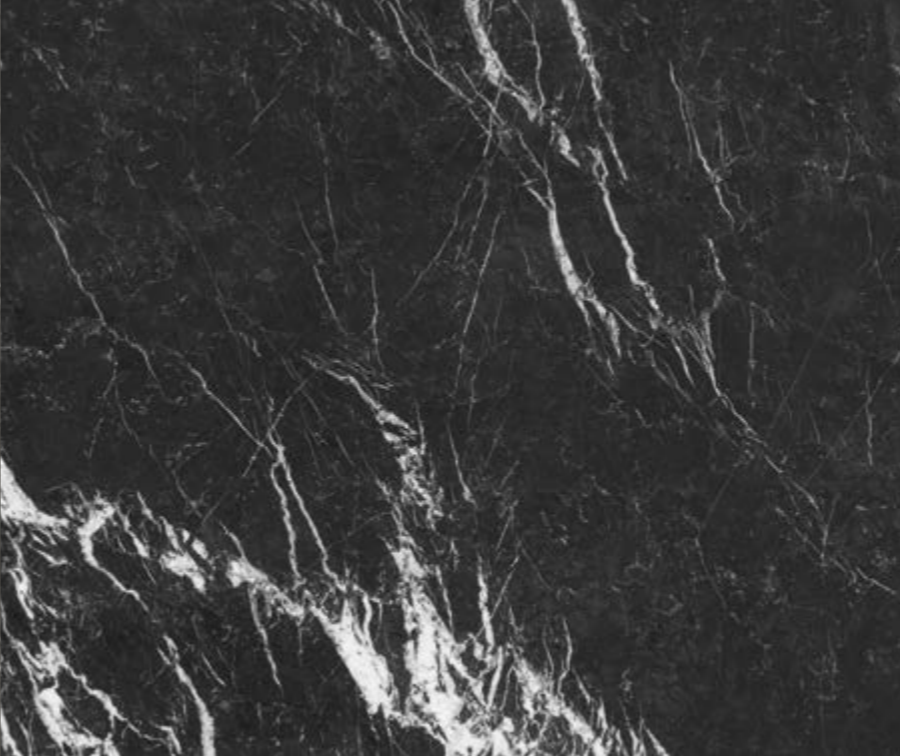

Greystone — Argent

Greystone — Smoke

Marquina — Black

Statuario plus

Colors / Colores

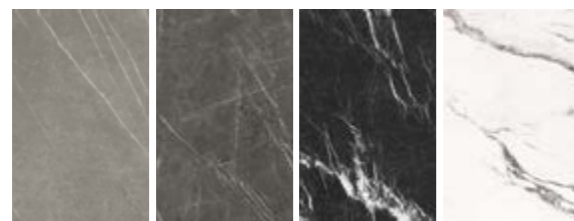

Argent Smoke Black Statuario plus

Finished / Acabados

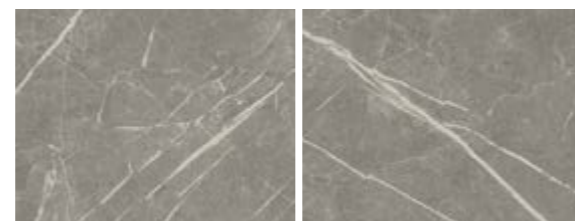

polished natural

Dimensions / Dimensiones

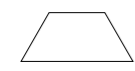

34,5 × 15 cm
13,6 × 5,9"



17,2 × 15 cm
6,7 × 5,9"

References / Referencias

References / Referencias	Price code
23558 TRAP. GREYSTONE ARGENT/34,5x15/EP	U28
23683 TRAP. GREYSTONE ARGENT/34,5x15/NAT	U28
23562 TRAP. GREYSTONE SMOKE/34,5x15/EP	U28
23684 TRAP. GREYSTONE SMOKE/34,5x15/NAT	U28
23563 TRAP. MARQUINA BLACK/34,5x15/EP	U28
23686 TRAP. MARQUINA BLACK/34,5x15/NAT	U28
23564 TRAP. STATUARIO PLUS/34,5x15/EP	U28
23685 TRAP. STATUARIO PLUS/34,5x15/EP	U28
23557 TRI. GREYSTONE ARGENT/17,2x15/EP	U13
23687 TRI. GREYSTONE ARGENT/17,2x15/NAT	U13
23559 TRI. GREYSTONE SMOKE/17,2x15/EP	U13
23688 TRI. GREYSTONE SMOKE/17,2x15/NAT	U13
23560 TRI. MARQUINA BLACK/17,2x15/EP	U13
23689 TRI. MARQUINA BLACK/17,2x15/NAT	U13
23561 TRI. STATUARIO PLUS/17,2x15/EP	U13
23690 TRI. STATUARIO PLUS/17,2x15/EP	U13

installation patterns. examples of possible combinations

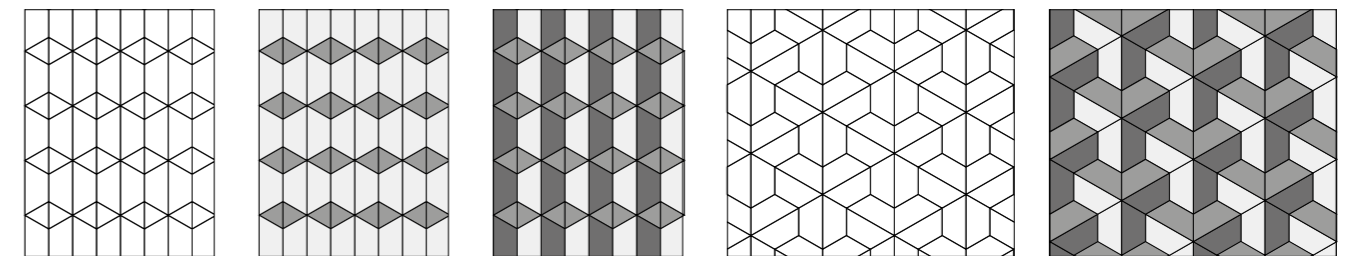

Pieces 1 m²
21 TRI. _ 21 TRAP.

Pieces 1 m²
30 TRAP.

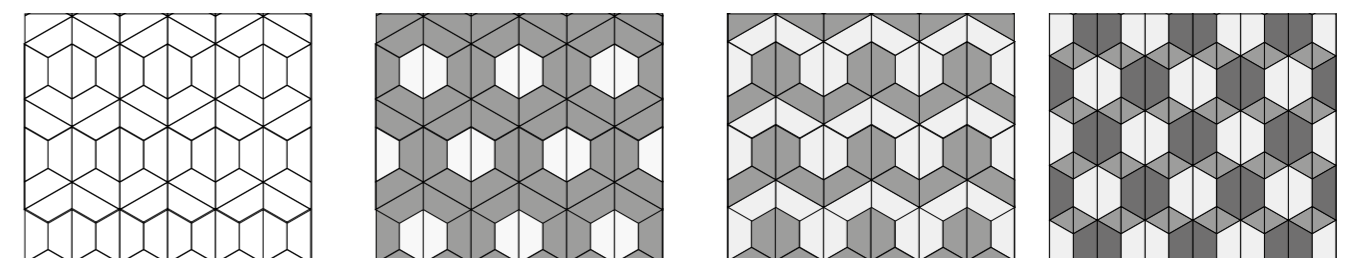

Pieces 1 m²
30 TRAP.

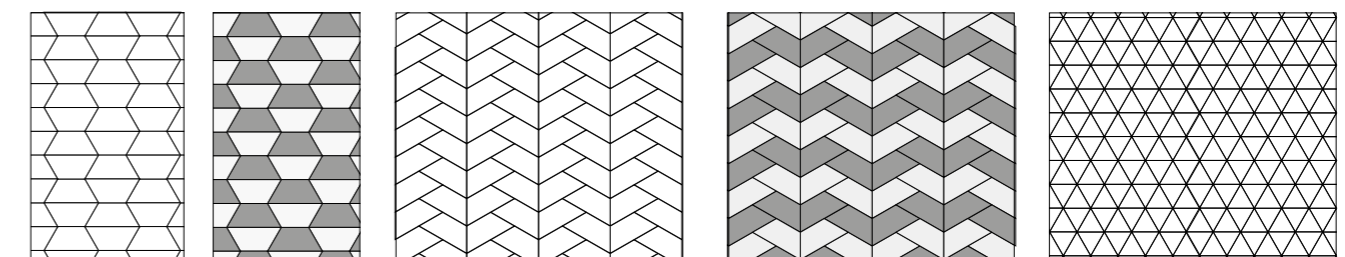

Pieces 1 m²
28 TRAP.

Pieces 1 m²
32 TRAP.

Pieces 1 m²
84 TRI..



Basati





Basati — Bianco

Colors / Colores



Bianco

Finished / Acabados

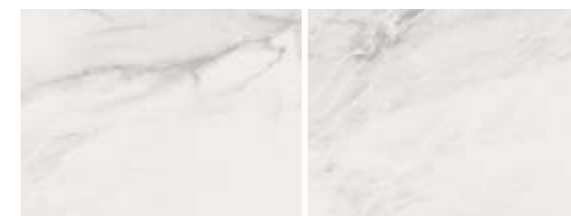

polished

natural

Decorados / Decors

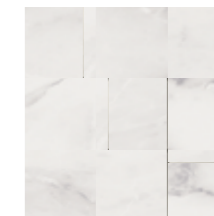

Bianco

Dimensions / Dimensiones

75,5 × 151 cm
29,7 × 59,4"

40 patterns

Shade variation: V2

References / Referencias

21068 BASATI BIANCO/75,5x151/EP
21071 BASATI BIANCO/75,5x151/NAT/R
22251 D. BASATI BIANCO MOSAIC/30X30

Price code

M58
M59
U58



Nara





Nara — White

Colors / Colores



White

Pearl

Finished / Acabados

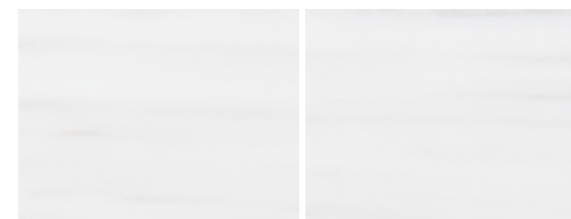

polished

natural

Dimensions / Dimensiones

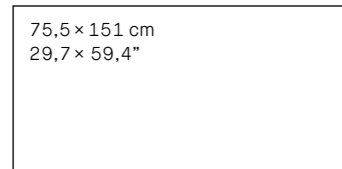

75,5 × 151 cm
29,7 × 59,4"

19 patterns

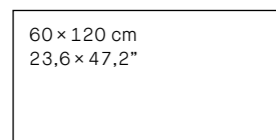

60 × 120 cm
23,6 × 47,2"

19 patterns

Shade variation: V2

References / Referencias

References / Referencias	Price code
22134 NARA WHITE/75,5x151/EP	M58
22138 NARA WHITE/75,5x151/NAT/R	M59
22106 NARA WHITE/60x120/EP	M40
22108 NARA WHITE/60x120/NAT/R	M66
22135 NARA PEARL/75,5x151/EP	M58
22139 NARA PEARL/75,5x151/NAT/R	M59
22107 NARA PEARL/60x120/EP	M40
22109 NARA PEARL/60x120/NAT/R	M66

Nara — Pearl

Decorados / Decors



White

Pearl

Dimensions / Dimensiones

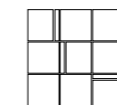



mixed finishes
polished | natural

30 × 30 cm
11,8 × 11,8"

References / Referencias

References / Referencias	Price code
22248 D. NARA WHITE MOSAIC/30X30	U58
22247 D. NARA PEARL MOSAIC/30X30	U58

22302 L.ALUMINUM/120/MATT U44 (0,5x120 cm - 0,19x47,2 ")   

22314 L.ALUMINUM/120/SHINE U44 (0,5x120 cm - 0,19x47,2 ")   



Onix



Onix



Onix — Pearl

Colors / Colores



pearl

Finished / Acabados



polished

Dimensions / Dimensiones

75,5 × 151 cm
29,7 × 59,4"

18 patterns

60 × 120 cm
23,6 × 47,2"

18 patterns

Shade variation: V2

References / Referencias

21069 ONIX PEARL/75,5x151/EP
22110 ONIX PEARL/60x120/EP

Price code

M58
M40



Santana



Santana — White

Colors / Colores



White

Finished / Acabados



polished

Dimensions / Dimensiones

75,5 × 151 cm
29,7 × 59,4"

14 patterns

60 × 120 cm
23,6 × 47,2"

15 patterns

Shade variation: V2

References / Referencias

22143 SANTANA WHITE/75,5x151/EP
22111 SANTANA WHITE/60x120/EP

Price code

M58
M40





Suite





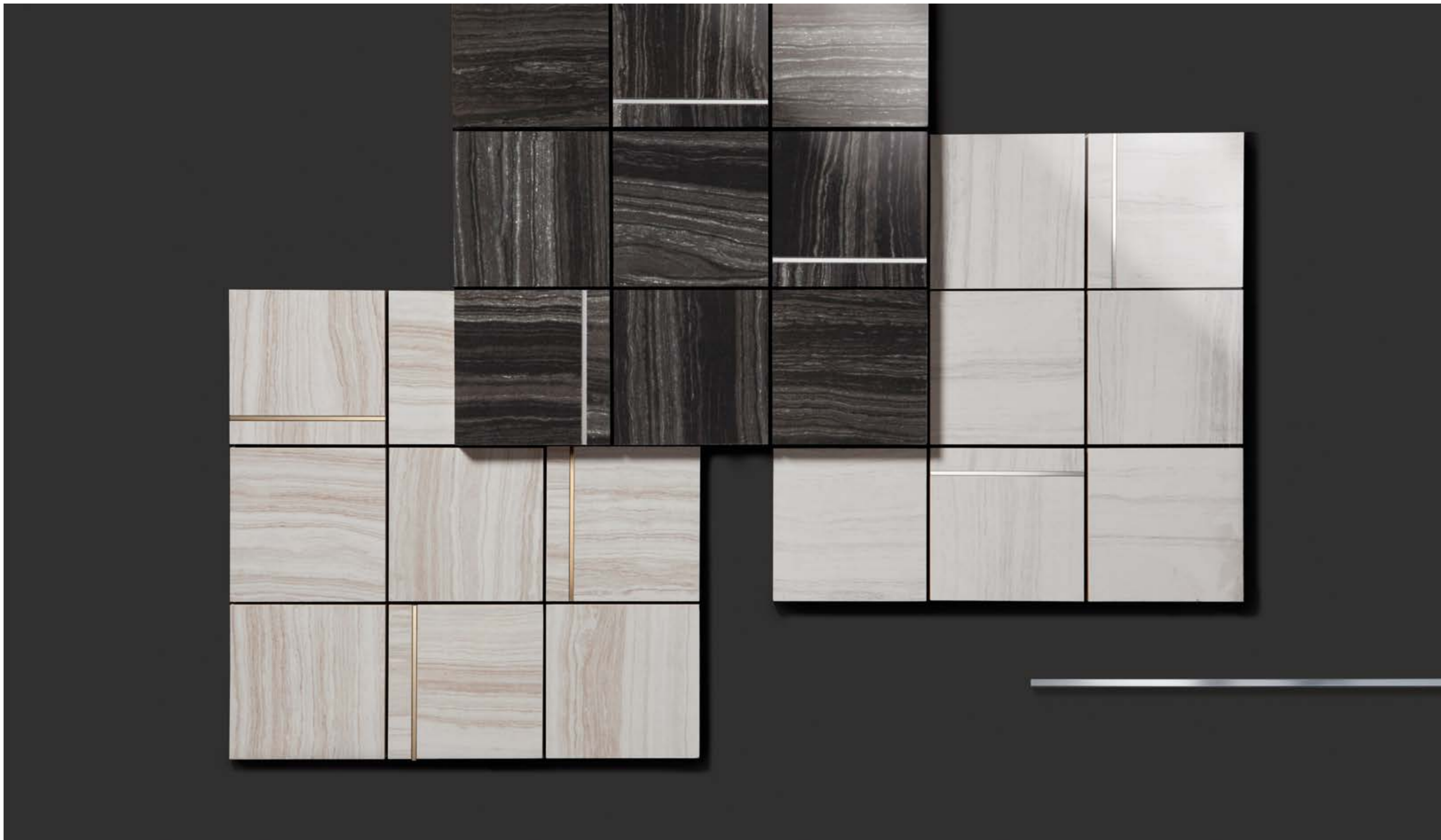



Suite

Colors / Colores

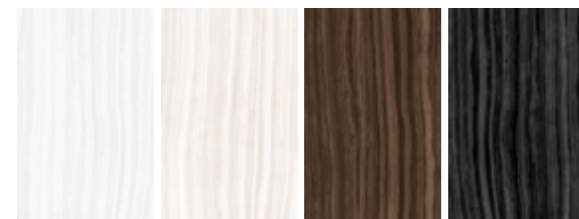

Pearl Beige Brown Black

Finished / Acabados

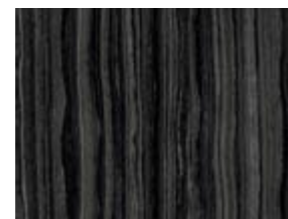

polished

Dimensions / Dimensiones

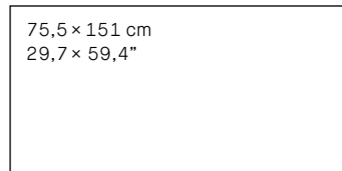

75,5 x 151 cm
29,7 x 59,4"

12 patterns

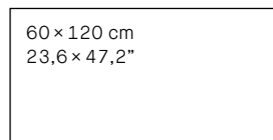

60 x 120 cm
23,6 x 47,2"

12 patterns

Shade variation: V2

References / Referencias

22126 SUITE PEARL/75,5x151/EP	M58
22102 SUITE PEARL/60x120/EP	M40
22127 SUITE BEIGE/75,5x151/EP	M58
22103 SUITE BEIGE/60x120/EP	M40
22128 SUITE BROWN/75,5x151/EP	M58
22101 SUITE BROWN/60x120/EP	M40
22129 SUITE BLACK/75,5x151/EP	M58
22100 SUITE BLACK/60x120/EP	M40

Price code

Suite

Decorados / Decors



Pearl Beige Brown Black Pearl-black Beige-brown

Dimensions / Dimensiones

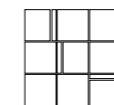

30 x 30 cm
11,8 x 11,8"



16 x 25 cm
6,3 x 9,8"

References / Referencias

22742 D. SUITE PEARL MOSAIC/30X30	U58
22740 D. SUITE BEIGE MOSAIC/30X30	U58
22741 D. SUITE BROWN MOSAIC/30X30	U58
22739 D. SUITE BLACK MOSAIC/30X30	U58
22775 D. SUITE PEARL MIX ARR./16X25	U49
22774 D. SUITE BEIGE MIX ARR./16X25	U49

Price code

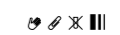



Torano







Torano — Bianco

Colors / Colores

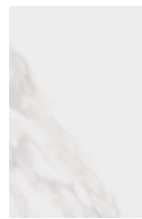

Bianco

Finished / Acabados



polished

natural

Decorados / Decors



Bianco

Dimensions / Dimensiones



75,5 × 151 cm
29,7 × 59,4"

40 patterns

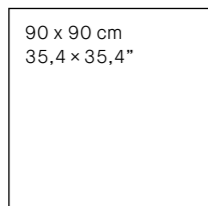

90 × 90 cm
35,4 × 35,4"

20 patterns

Shade variation: V2

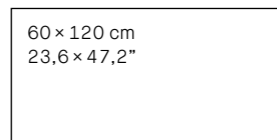

60 × 120 cm
23,6 × 47,2"

35 patterns

References / Referencias

References / Referencias	Price code
21070 TORANO BIANCO/75,5x151/EP	M58
21074 TORANO BIANCO/75,5x151/NAT/R	M59
22011 TORANO BIANCO/60x120/EP	M40
22012 TORANO BIANCO/60x120/NAT/R	M66
22061 TORANO BIANCO/90x90/EP	M2
22062 TORANO BIANCO/90x90/NAT/R	M68

Dimensions / Dimensiones

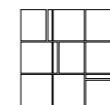

30 × 30 cm
11,8 × 11,8"

mixed
finishes
polished | natural

References / Referencias

References / Referencias	Price code
22252 D. TORANO BIANCO MOSAIC/30X30	U58

22302 L.ALUMINUM/120/MATT U44 (0,5x120 cm - 0,19x47,2 ")

22314 L.ALUMINUM/120/SHINE U44 (0,5x120 cm - 0,19x47,2 ")



Fidias





Fidias — B

Colors / Colores



B

Finished / Acabados



premium polished

Decorados / Decors



B

Dimensions / Dimensiones

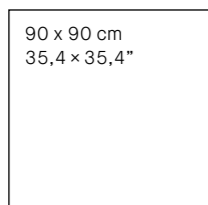

90 x 90 cm
35,4 x 35,4"

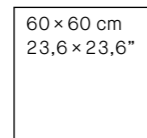

60 x 60 cm
23,6 x 23,6"

12 patterns

33 patterns

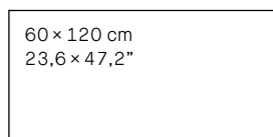

60 x 120 cm
23,6 x 47,2"

16 patterns

Shade variation: V2

References / Referencias

20121 FIDIAS-B/90x90/EP
11618 FIDIAS-B/60/P
19253 FIDIAS-B/60x120/EP

Price code

M2
M37
M-40

Dimensions / Dimensiones

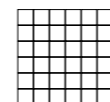

30 x 30 cm
11,8 x 11,8"

References / Referencias

19548 D. FIDIAS-B/5/EP	U49
* 11832 ROS. ELENA-B/120/P (120x120 cm-47,2x47,2")	U94
11834 C. ELENA-B/60/P (18x60 cm-7,1x23,6")	U77
11833 E. ELENA-B/60/P (18x18 cm-7,1x7,1")	U52
11880 L. FIDIAS-B/60/P (5x60 cm-1,9x23,6")	U28
11882 T. FIDIAS-B/5/P (5x5 cm-1,9x1,9")	U11
11881 L. LUXURY-N/60/P (5x60 cm-1,9x23,6")	U28
11883 T. LUXURY-N/60/P (5x5 cm-1,9x1,9")	U11

Price code

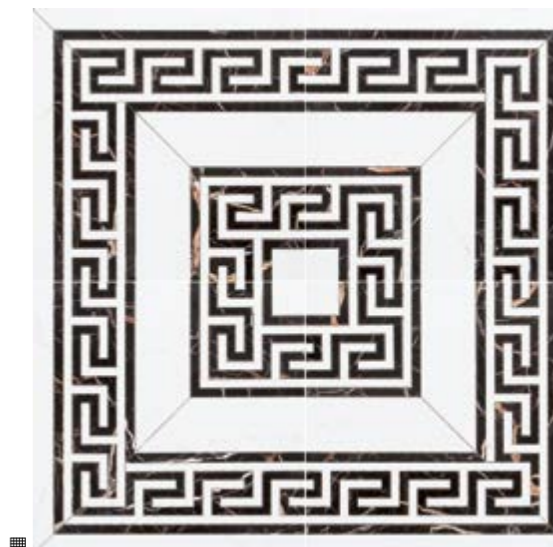

* 11832



11834

11833

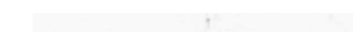

11880



11882



11881



11883

* Cualquier cambio de color en este rosetón, incrementará su precio de tarifa un 100%.
Any change of colour of this rosette will increase its tariff price by 100%.



Freeze



Freeze — W

Colors / Colores



W

Finished / Acabados



polished

Dimensions / Dimensiones

90 x 90 cm
35,4 x 35,4"

32 patterns

60 x 120 cm
23,6 x 47,2"

18 patterns

Shade variation: V2

References / Referencias

Price code

18672 FREEZE-W/90x90/EP
18671 FREEZE-W/60x120/EP

M2
M40



Gioia





Gioia — Silver

Gioia — Gold

Colors / Colores



Silver Gold

Finished / Acabados



polished

Decorados / Decors

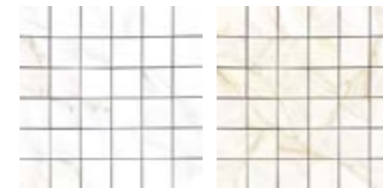

Silver Gold

Dimensions / Dimensiones

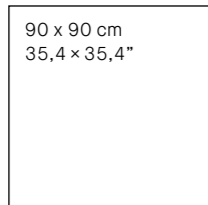

90 x 90 cm
35,4 x 35,4"

15 patterns

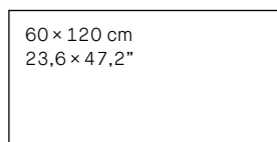

60 x 120 cm
23,6 x 47,2"

15 patterns

Shade variation: V2

References / Referencias

References / Referencias	Price code
19648 GIOIA SILVER/90x90/EP	M2
19507 GIOIA SILVER/60x120/EP	M40
19647 GIOIA GOLD/90x90/EP	M2
19508 GIOIA GOLD/60x120/EP	M40

Dimensions / Dimensiones

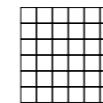

30 x 30 cm
11,8 x 11,8"

References / Referencias

References / Referencias	Price code
19662 D. GIOIA SILVER/5/EP	U49
19661 D. GIOIA GOLD/5/EP	U49

22314 L.ALUMINUM/120/SHINE U44 (0,5x120 cm - 0,19x47,2 ")

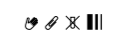



Hettangian floor







Hettangian floor

Colors / Colores



Ivory

Grey

Beige

Finished / Acabados



polished

Dimensions / Dimensiones

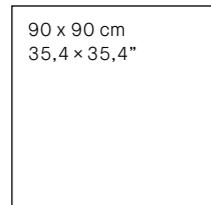

90 x 90 cm
35,4 x 35,4"

30 patterns

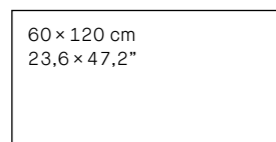

60 x 120 cm
23,6 x 47,2"

14 patterns

Shade variation: V2

References / Referencias

References / Referencias	Price code
18019 HETTANGIAN-I/90x90/EP	M2
19052 HETTANGIAN-I/60x120/EP	M40
18201 HETTANGIAN-G/90x90/EP	M2
19051 HETTANGIAN-G/60x120/EP	M40
15821 HETTANGIAN-B/90x90/EP	M2

Hettangian floor

Decorados / Decors

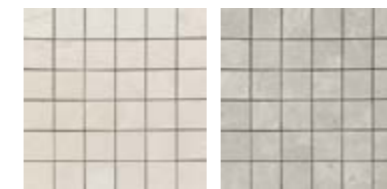

Ivory

Grey

Dimensions / Dimensiones

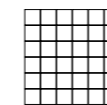

30 x 30 cm
11,8 x 11,8"

References / Referencias

References / Referencias	Price code
19545 D. HETTANGIAN-I/5/EP	U49
19546 D. HETTANGIAN-G/5/EP	U49
17546 D. HETTANGIAN-B/90/1/EP (90x90 cm-35,4x35,4")	U72
17338 T. I. HETTANGIAN-B/90/EP (41x41 cm-16,1x16,1")	U75
17335 C. HETTANGIAN-B/90/EP (15x90 cm-5,9x35,4")	U69
17336 E. HETTANGIAN-B/90/EP (15x15 cm-5,9x5,9")	U49

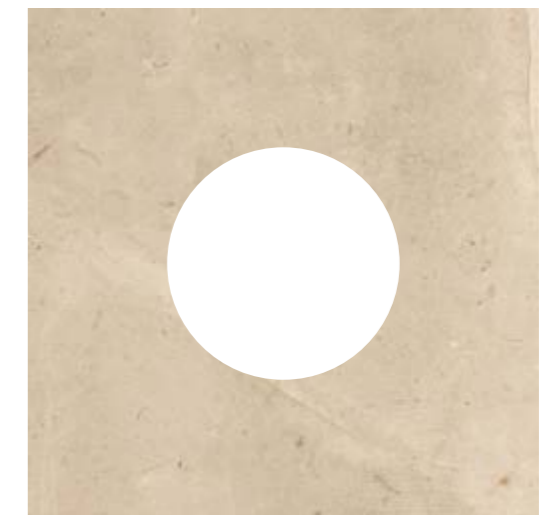

17546



X

17338



X

17335

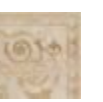

X

17336



Kritios





Kritios

Colors / Colores



Kritios

Finished / Acabados



polished

Dimensions / Dimensiones

90 x 90 cm
35,4 x 35,4"

16 patterns

60 x 120 cm
23,6 x 47,2"

16 patterns

Shade variation: V2

References / Referencias

20386 KRITIOS/90x90/EP
20363 KRITIOS/60x120/EP

Price code

M2
M40



Madison





Madison

Colors / Colores



Madison

Finished / Acabados

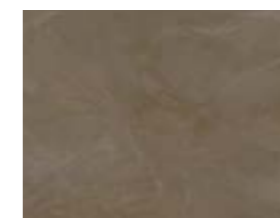

polished

Dimensions / Dimensiones

90 x 90 cm
35,4 x 35,4"

10 patterns

60 x 120 cm
23,6 x 47,2"

18 patterns

Shade variation: V2

References / Referencias

Price code

21064 MADISON/90x90/EP
21065 MADISON/60x120/EP

M2
M40



Metropolitan floor

BUSINESS
AREA



Metropolitan floor — B

Metropolitan floor — B

Colors / Colores



B

Finished / Acabados



polished

Decorados / Decors



B

Dimensions / Dimensiones

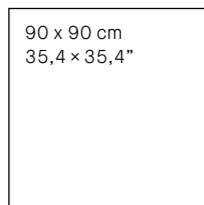

90 x 90 cm
35,4 x 35,4"

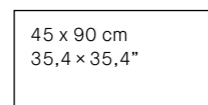

45 x 90 cm
35,4 x 35,4"

12 patterns

24 patterns

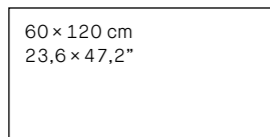

60 x 120 cm
23,6 x 47,2"

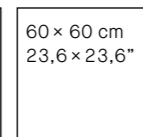

60 x 60 cm
23,6 x 23,6"

35 patterns

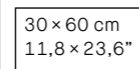

30 x 60 cm
11,8 x 23,6"

70 patterns

Shade variation: V3

References / Referencias

References / Referencias	Price code
15829 METROPOLITAN-B/90x90/EP	M2
16703 METROPOLITAN-B/45x90/EP	M2
16777 METROPOLITAN-B/60x120/EP	M40
17089 METROPOLITAN-B/60x60/EP	M4
17307 METROPOLITAN-B/60x60/MAT/R	M60
17540 METROPOLITAN-B/30x60/EP	M4
17587 METROPOLITAN-B/30x60/MAT/R	M64

Dimensions / Dimensiones

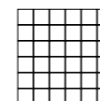

30,2 x 30,2 cm
11,8 x 11,8"

References / Referencias

References / Referencias	Price code
17596 D.METROPOLITAN-B/5	U49
17547 D.METROPOLITAN-B/90/1/EP (90x90 cm-35,4x35,4")	U72
17372 T. I. METROPOLITAN-B/90/EP (41x41 cm-16,1x16,1")	U75
17370 C. METROPOLITAN-B/90/EP (15x90 cm-5,9x35,4")	U69
17371 E. METROPOLITAN-B/90/EP (15x15 cm-5,9x5,9")	U49
17634 D. ILLINOIS-B/60/EP (60x60 cm-23,6x23,6")	U70



17547



17372

17634



17370



17371



Orio



Orio — H

Colors / Colores



H

Finished / Acabados



polished

Dimensions / Dimensiones

90 x 90 cm
35,4 x 35,4"

12 patterns
Shade variation: V3

References / Referencias

15826 ORIO-H/90/EP

Price code

M2



State



State — B

Colors / Colores



B

Finished / Acabados



polished

Dimensions / Dimensiones

90 x 90 cm
35,4 x 35,4"

20 patterns
Shade variation: V2

References / Referencias

20120 STATE-B/90x90/EP

Price code

M2



Stiava





Stiava

Colors / Colores



Stiava

Finished / Acabados



polished

Dimensions / Dimensiones

90 x 90 cm
35,4 x 35,4"

13 patterns

60 x 120 cm
23,6 x 47,2"

17 patterns

Shade variation: V2

References / Referencias

20385 STIAVA/90x90/EP
20362 STIAVA/60x120/EP

Price code

M2
M40



Sunshine





Sunshine — B

Colors / Colores



B

Finished / Acabados

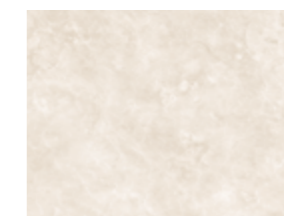

polished

Decorados / Decors



B

Dimensions / Dimensiones

90 x 90 cm
35,4 x 35,4"

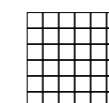

29,9 x 29,9 cm
11,7 x 11,7"

14 patterns

60 x 120 cm
23,6 x 47,2"

18 patterns

Shade variation: V2

References / Referencias

Price code

18669 SUNSHINE-B/90x90/EP

M2

18495 SUNSHINE-B/60x120/EP

M40

19550 D. SUNSHINE-B/5/EP

U49



Grevin



Grevin — H

Colors / Colores



H

Finished / Acabados



polished

Decorados / Decors

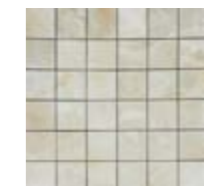

H

Dimensions / Dimensiones

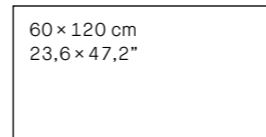

60 × 120 cm
23,6 × 47,2"

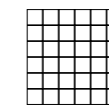

29,9 × 29,9 cm
11,7 × 11,7"

8 patterns

Shade variation: V3

References / Referencias

Price code

19252 GREVIN-H/60x120/EP

M40

19547 D.GREVIN-H/5/EP

U49



Lens









Lens

Colors / Colores



White Taupe Silver Grey

Finished / Acabados



river-washed

Dimensions / Dimensiones

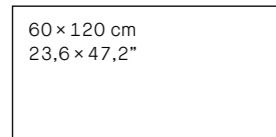

60 × 120 cm
23,6 × 47,2"

22 patterns

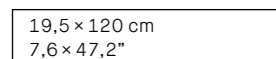

19,5 × 120 cm
7,6 × 47,2"

66 patterns

Shade variation: V2

References / Referencias

References / Referencias	Price code
22233 LENS WHITE/60x120/RW/R	M66
22237 LENS WHITE/19,5x120/RW/R	M67
22234 LENS TAUPE/60x120/RW/R	M66
22238 LENS TAUPE/19,5x120/RW/R	M67
22232 LENS SILVER/60x120/RW/R	M66
22236 LENS SILVER/19,5x120/RW/R	M67
22231 LENS GREY/60x120/RW/R	M66
22235 LENS GREY/19,5x120/RW/R	M67

Lens

Decorados / Decors



White Taupe Silver Grey White Taupe Silver Grey

Dimensions / Dimensiones

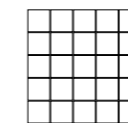

30 × 30 cm
11,8 × 11,8"



29,8 × 29,2 cm
11,7 × 11,5"

References / Referencias

References / Referencias	Price code
22776 D. LENS WHITE MOSAIC/30X30/RW	U39
22790 D. LENS WHITE/29,8X29,2/RW	U50
22777 D. LENS TAUPE MOSAIC/30X30/RW	U39
22791 D. LENS TAUPE BRICK/29,8X29,2/RW	U50
22779 D. LENS SILVER MOSAIC/30X30/RW	U39
22792 D. LENS SILVER BRICK/29,8X29,2/RW	U50
22778 D. LENS GREY MOSAIC/30X30/RW	U39
22793 D. LENS GREY BRICK/29,8X29,2/RW	U50





Lumina



Lumina — B

Colors / Colores



B

Finished / Acabados



premium polished

polished

Decorados / Decors

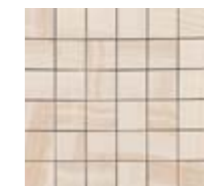

B

Dimensions / Dimensiones

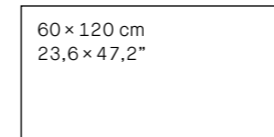

9 patterns
Shade variation: V2

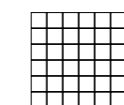

30 x 30 cm
11,8 x 11,8"

References / Referencias

14295 LUMINA-B/120/P
19254 LUMINA-B/60x120/EP
19549 D. LUMINA-B/5/EP

Price code

M46
M40
U49



Marq



Marq — H

Colors / Colores



H

Finished / Acabados

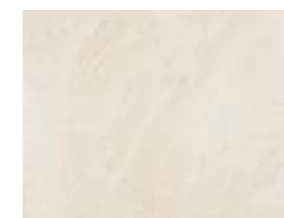

polished

Dimensions / Dimensiones

60 × 120 cm
23,6 × 47,2"

15 patterns
Shade variation: V1

References / Referencias

20216 MARQ-H/60x120/EP

Price code

M40



Menhir



Menhir — H

Colors / Colores



H

Finished / Acabados



premium polished

Dimensions / Dimensiones

60 × 120 cm
23,6 × 47,2"

9 patterns

Shade variation: V1

References / Referencias

16205 MENHIR-G/120/P

Price code

M46

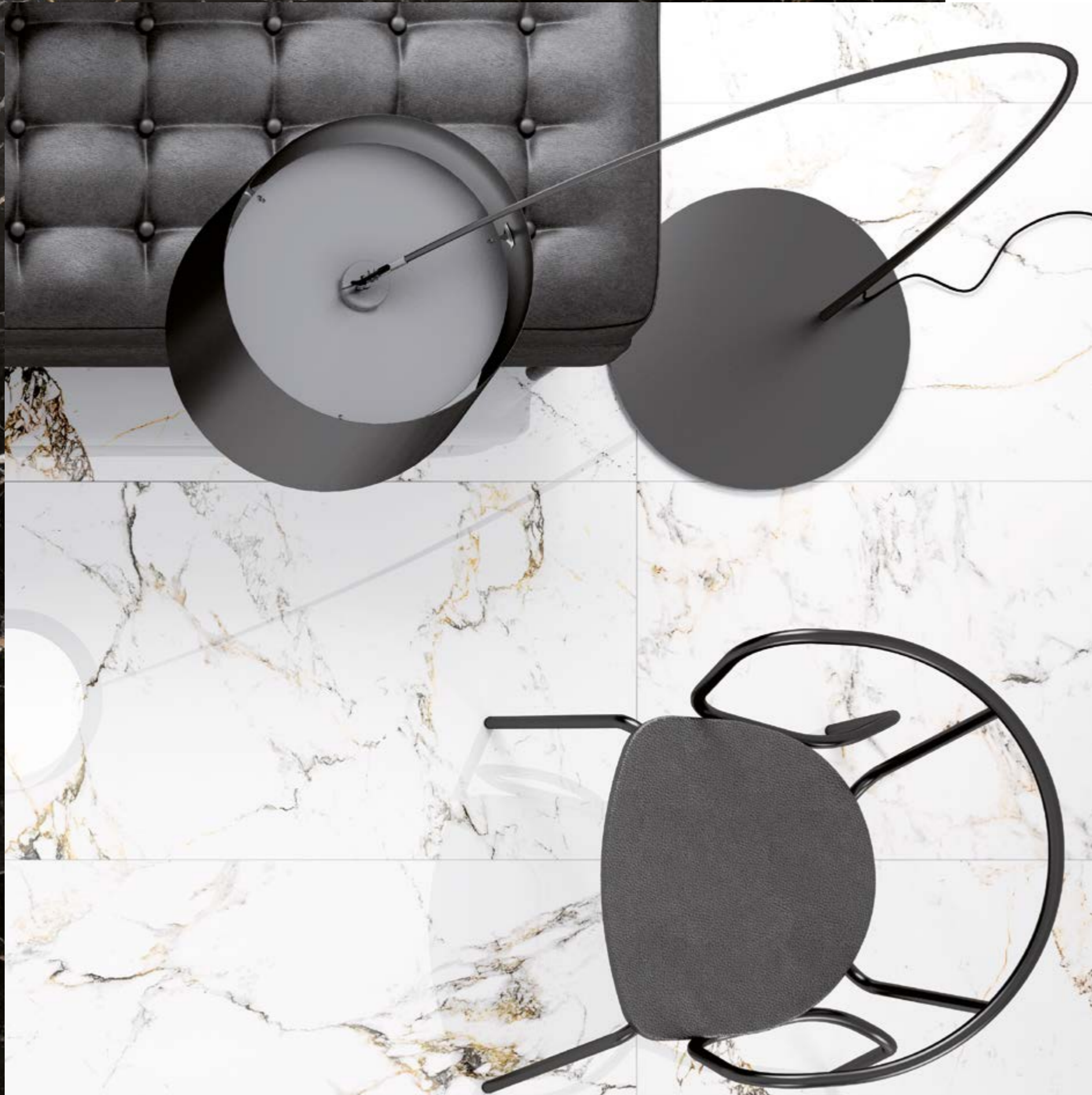

Tucci







Tucci — Black



Tucci — Gold

Colors / Colores

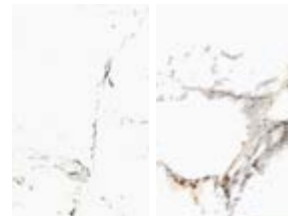

Black

Gold

Finished / Acabados



premium polished

Dimensions / Dimensiones

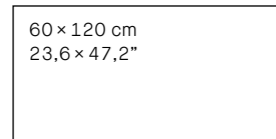

11 patterns

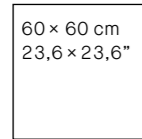

22 patterns

Shade variation: V2

References / Referencias

20387	TUCCI BLACK/60x120/P
20577	TUCCI BLACK/60x60/P
20388	TUCCI GOLD/60x120/P
20578	TUCCI GOLD/60x60/P

Price code

M46
M37
M46
M37

Decorados / Decors



20832



20831

References / Referencias

20832	ROS. TUCCI BLACK/P (120x120 cm-47,2x47,2")
20831	ROS. TUCCI GOLD/P (120x120 cm-47,2x47,2")

Price code

U88
U88



Vogue



Vogue — B

Colors / Colores



B

Finished / Acabados



premium polished

Dimensions / Dimensiones

60 × 120 cm
23,6 × 47,2"

20 patterns
Shade variation: V1

References / Referencias

12949 VOGUE-B/120/P

Price code

M46

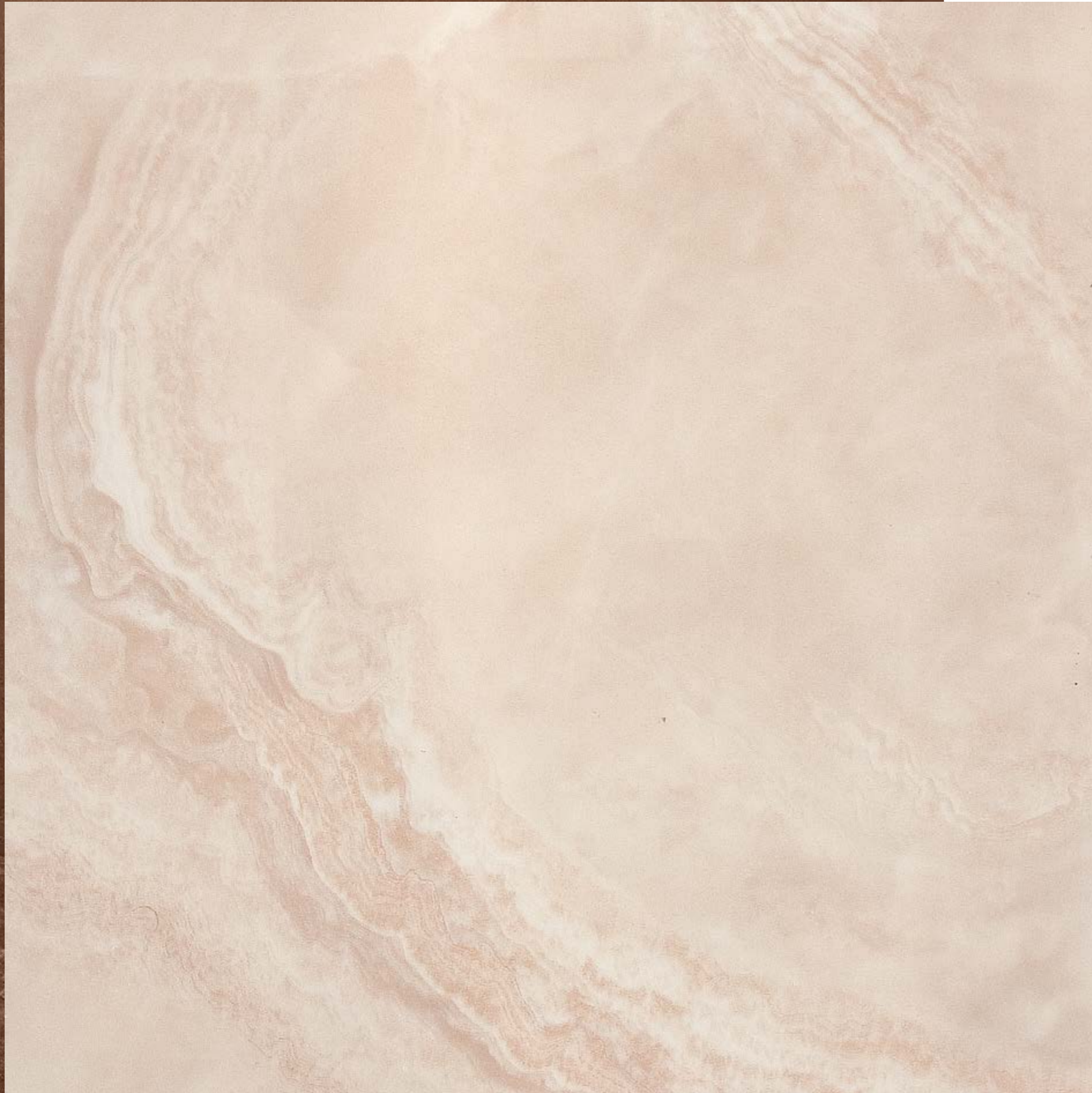

Agatha



Agatha

Colors / Colores



H

M

Finished / Acabados



premium polished

Dimensions / Dimensiones

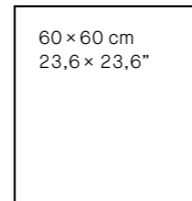

60 × 60 cm
23,6 × 23,6"

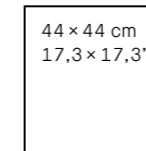

44 × 44 cm
17,3 × 17,3"

6 patterns

6 patterns

Shade variation: V2

References / Referencias

Price code

11892 AGATHA-H/60/P	M-37
11320 AGATHA-H/44/P	M-30
11921 AGATHA-M/60/P	M-37
11322 AGATHA-M/44/P	M-30



Agatha

Decorados / Decors

References / Referencias	Price code
*11955 ROS. FONTAINE/120/P (120x120 cm-47,2x47,2")	U98
*11609 ROS. FONTAINE/88/P (88x88 cm-34,6x34,6")	U84
11624 C. FONTAINE/44/P (10x44 cm-3,9x17,3")	U69
11623 E. FONTAINE/44/P (10x10 cm-3,9x3,9")	U60
11602 C. GINGER-M/44/P (13x44 cm-5,1x17,3")	U69
11604 E. GINGER-M/44/P (13x13 cm-5,1x5,1")	U60
11590 E.D. FONTAINE/44/P (44x44 cm-17,3x17,3")	U90
11591 L.D. FONTAINE/44/P (44x44 cm-17,3x17,3")	U90
08143 T.I. SOFIA/P (29x29 cm-11,4x11,4")	U70
10137 C. SOFIA/60/P (7x60 cm-2,7x23,6")	U85
08146 C. SOFIA/P (7x44 cm-2,7x17,3")	U61
08145 C. LOREN/P (4x44 cm-1,5x17,3")	U52
08147 T. SOFIA/P (7x7 cm-2,7x47,2")	U69
08468 T. LOREN/P (4x4 cm-1,5x47,2")	U64



*11955



*11609



11624



11623



11602



11604



11590



11591



08143

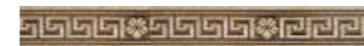

10137



08147



08146



08145



08468

* Cualquier cambio de color en este rosetón, incrementará su precio de tarifa un 100%. – Any change of colour of this rosette will increase its tariff price by 100%.



Capital



Capital — B

Colors / Colores



B

Finished / Acabados

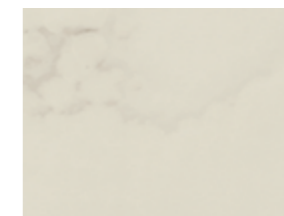

premium polished

Dimensions / Dimensiones

60 × 60 cm
23,6 × 23,6"

36 patterns
Shade variation: V2

References / Referencias

16745 CAPITAL-B/60/P

Price code

M37



Macba - Muvim

Macba



Muvim



Macba — Muvim

Colors / Colores



Argent

Finished / Acabados



premium polished

Dimensions / Dimensiones

60 × 60 cm
23,6 × 23,6"

44 × 44 cm
17,3 × 17,3"

MACBA
13 patterns
Shade variation: V2

MUVIM
46 patterns

References / Referencias

Price code

10102 MACBA-M/P
07801 MUVIM-M/P

M37
M30



Macba — Muvim

Decorados / Decors



Dimensions / Dimensiones

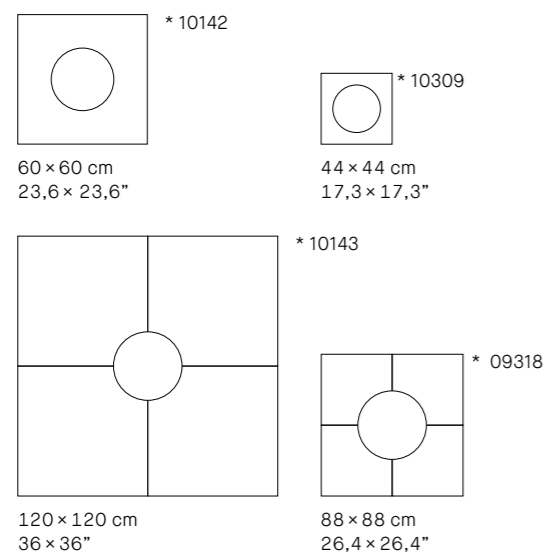

References / Referencias

References / Referencias	Price code
* 10142 D. MACBA-M/1/P (60x60 cm-23.6x23.6")	U61
* 10309 D. MUVIM-M/1/P (44x44 cm-17.3x17.3")	U66
* 10143 D. MACBA-M/4/P (120x120 cm-47.2x47.2")	U86
* 09318 D. MUVIM-M/4/P (88x88 cm-34.6x34.6")	U82
08143 T. I. SOFIA/P (29x29 cm-11.4x11.4")	U70
10137 C. SOFIA/60/P (7x60 cm-2.7x23.6")	U85
08146 C. SOFIA/P (7x44 cm-2.7x17.3")	U61
08145 C. LOREN/P (7x44 cm-2.7x17.3")	U52
08147 T. SOFIA/P (7x7 cm-2.7x47.2")	U69
08468 T. LOREN/P (4x4 cm-1.5x1.5")	U64
* 10168 O.B. MACBA-M/8/P (120x240 cm-47.2x94.4")	U100
* 10247 O.B. MUVIM-M/8/P (88x176 cm-34.6x69.2")	U90
08144 ROS. SOFIA/P (88x88 cm-34.6x34.6")	U63
08719 ROS. LOREN/P (88x88 cm-34.6x34.6")	U83

* Se fabrica en todos los colores de las bases. They are manufactured in all the colour of the bases.



08144



08719



*10168

* El precio corresponde al decorado completo, que se comercializa como una unidad. The price corresponds to the complete decor, that is sold as a whole unit.



*10247

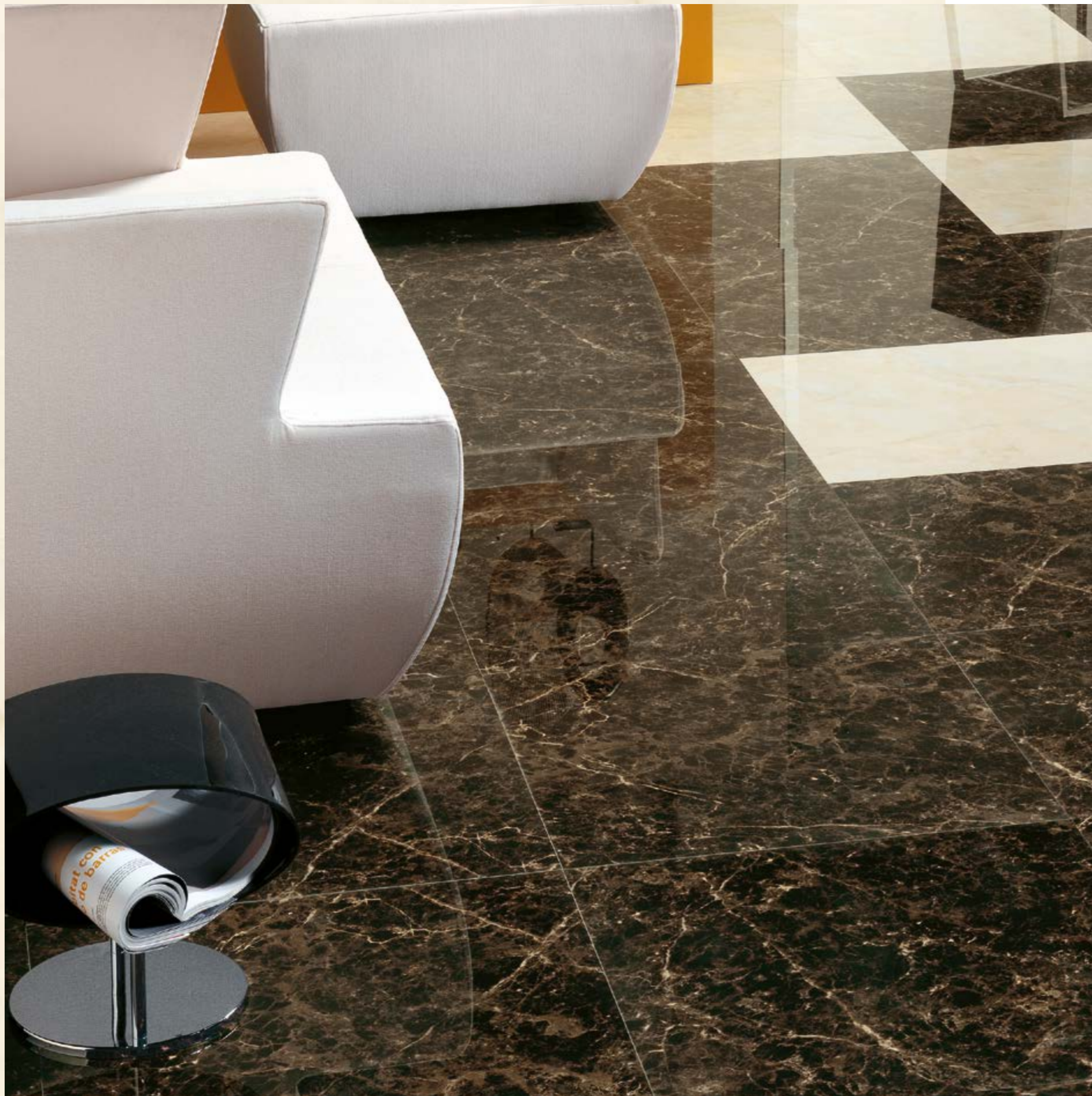

Opalo—Onice
Bach—Zar



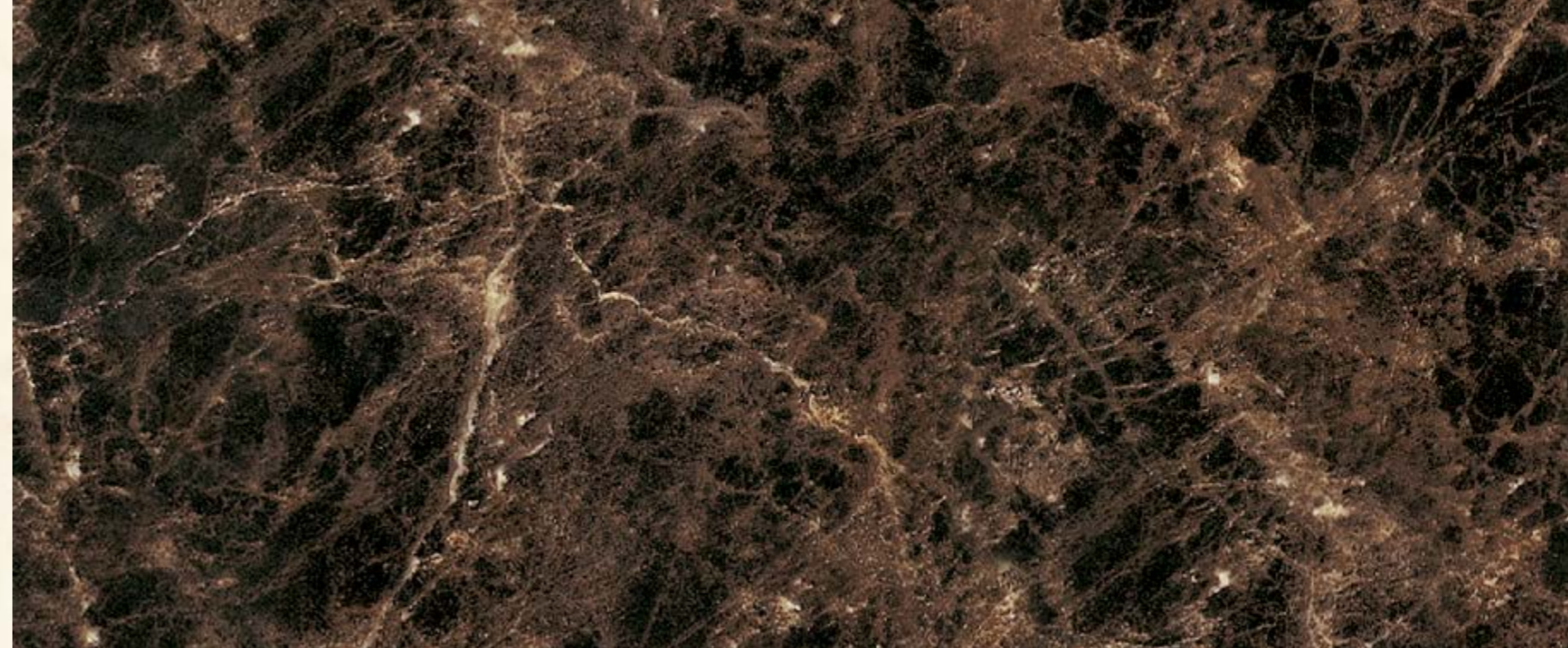

Opalo — Onice

Bach — Zar

Colors / Colores

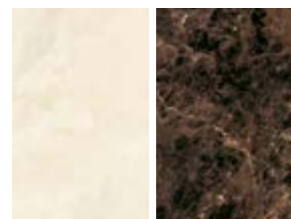

B

M

Finished / Acabados

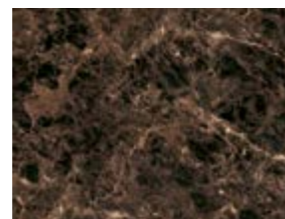

premium polished

Dimensions / Dimensiones

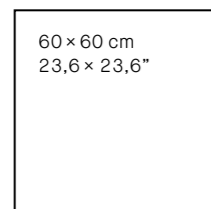

OPALO—BACH
6 patterns
Shade variation: V2

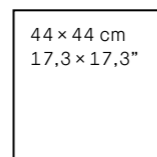

ONICE—ZAR
12 patterns

References / Referencias

References / Referencias	Price code
07968 OPALO-B/P (60x60 cm-23,6x23,6")	M-37
06468 ONICE-B/P (44x44 cm-17,3x17,3")	M-30
08215 BACH-M/P (60x60 cm-23,6x23,6")	M-37
06427 ZAR-M/P (44x44 cm-17,3x17,3")	M-30

Decorados / Decors

References / Referencias

Price code

* 11626 ROS. BEAUTY/P (120x120 cm-47,2x47,2")	U94
* 08156 ROS. CATHERINE/P (88x88 cm-34,6x34,6")	U84
11397 C. BEAUTY/P (18x60 cm-7,1x23,6")	U77
11398 E. BEAUTY/P (18x18 cm-7,1x7,1")	U52



* 11626



* 08156



11397



11398

* Cualquier cambio de color en este rosetón, incrementará su precio de tarifa un 100%. — Any change of colour of this rosette will increase its tariff price by 100%.



Persepolis



Persepolis — M

Colors / Colores



M

Finished / Acabados



premium polished

Dimensions / Dimensiones

60 × 60 cm
23,6 × 23,6"

44 × 44 cm
17,3 × 17,3"

82 patterns

44 patterns

Shade variation: V2

References / Referencias

Price code

12942 PERSEPOLIS-M/60/P
12961 PERSEPOLIS-M/44/P

M37
M30



Persepolis — M

Decorados / Decors

References / Referencias	Price code
13348 ESTAMBUL-M/60/P (60x60 cm-23,6x23,6")	M46
13451 CARTAGO-M/44/P (44x44 cm-17,3x17,3")	M43
* 13440 ROS. MUSA-M/120/P (120x120 cm-47,2x47,2")	U99
13442 C. MUSA/1/60/P (22x60 cm-8,6x23,6")	U72
13443 C. MUSA/2/60/P (22x60 cm-8,6x23,6")	U64
13441 E. MUSA/60/P (22x22 cm-8,6x8,6")	U71
* 13220 ROS. MUSA-M/88/P (88x88 cm-34,6x34,6")	U97
13221 C. MUSA/1/44/P (22x44 cm-8,6x17,3")	U87
13222 C. MUSA/2/44/P (22x44 cm-8,6x17,3")	U62
13223 E. MUSA/44/P (22x22 cm-8,6x8,6")	U66
13187 L. PERSEPOLIS-M/60/P (5x60 cm-1,9x23,6")	U28
13188 L. PERSEPOLIS-M/44/P (3x44 cm-1,2x17,3")	U14
13189 T. PERSEPOLIS-M/60/P (5x5 cm-1,9x1,9")	U11
13190 T. PERSEPOLIS-M/44/P	U8



13348



13451



* 13440



13442



13441



13443



13187



13189



* 13220



13221



13223



13222



13188



13190

* Cualquier cambio de color en este rosetón, incrementará su precio de tarifa un 100%. — Any change of colour of this rosette will increase its tariff price by 100%.



Petra



Petra — B

Colors / Colores



B

Finished / Acabados



premium polished

Dimensions / Dimensiones

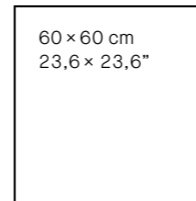

60 × 60 cm
23,6 × 23,6"

37 patterns

Shade variation: V2

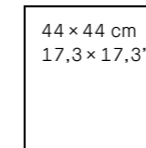

44 × 44 cm
17,3 × 17,3"

69 patterns

References / Referencias

Price code

12941 PETRA-B/60/P
12963 PETRA-B/44/P

M37
M30

Petra — B

Decorados / Decors

References / Referencias

Price code

13357 ESTAMBUL-B/60/P (60x60 cm-23,6x23,6")	M46
13439 CARTAGO-B/44/P	M43
13375 AVARIS/60/P (60x60 cm-23,6x23,6")	M46
13453 AVARIS/44/P (44x44 cm-17,3x17,3")	M43
10543 T.I. GINA/P (29x29 cm-11,4x11,4")	U70
10544 C. GINA/P (4x44 cm-1,5x17,3")	U52
10546 T. GINA/P (4x4 cm-1,5x1,5")	U64
*13402 ROS. MUSA-B/120/P (120x120 cm-47,2x47,2")	U99
13442 C. MUSA/1/60/P (22x60 cm-8,6x23,6")	U72
13443 C. MUSA/2/60/P (22x60 cm-8,6x23,6")	U64
13441 E. MUSA/60/P (22x22 cm-8,6x8,6")	U71
* 13231 ROS. MUSA-B/88/P (88x88 cm-34,6x34,6")	U97
13221 C. MUSA/1/44/P (22x44 cm-8,6x17,3")	U87
13222 C. MUSA/2/44/P (22x44 cm-8,6x17,3")	U62
13223 E. MUSA/44/P (22x22 cm-8,6x8,6")	U66
13193 L. PETRA-B/60/P (5x60 cm-1,9x23,6")	U28
13192 T. PETRA-B/60/P (5x5 cm-1,9x1,9")	U11
13194 L. PETRA-B/44/P (3x44 cm-1,2x17,3")	U14
13191 T. PETRA-B/44/P (3x3 cm-1,2x1,2")	U8



13375 — 8 patterns



13357



13453 — 8 patterns



13439



10543



10544



10546



*13402



* 13231



13442



13441



13221



13223



13443



13222



13193



13192



13194



13191

* Cualquier cambio de color en este rosetón, incrementará su precio de tarifa un 100%. — Any change of colour of this rosette will increase its tariff price by 100%.



Luxury



Luxury — N

Colors / Colores



N

Finished / Acabados



premium polished

Decorados / Decors

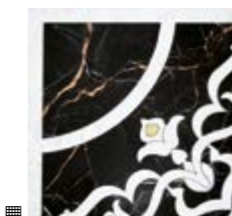

09903



09901

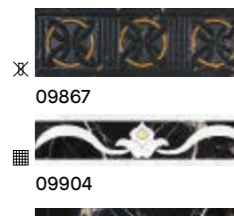

09867

09904

11463



09865

09902

10675

Dimensions / Dimensiones

44 × 44 cm
17,3 × 17,3"

12 patterns

Shade variation: V2

References / Referencias

Reference	Price code
09676 LUXURY-N/P (44x44 cm-17,3x17,3")	M30
09903 E.D. LUXURY-N/P (44x44 cm-17,3x17,3")	U80
09901 L.D. LUXURY-N/P (44x44 cm-17,3x17,3")	U86
09867 C. ORIENT-N/P (13,5x44 cm-5,3x17,3")	U64
09865 E. ORIENT-N/P (13,5x13,5 cm-5,3x5,3")	U46
09904 C. LUXURY-N/P (10x44 cm-3,9x17,3")	U68
09902 E. LUXURY-N/P (10x10 cm-3,9x3,9")	U53
11463 L. LUXURY-N/P (3x44 cm-1,2x17,3")	U14
10675 T. LUXURY-N/P (3x3 cm-1,2x1,2")	U8

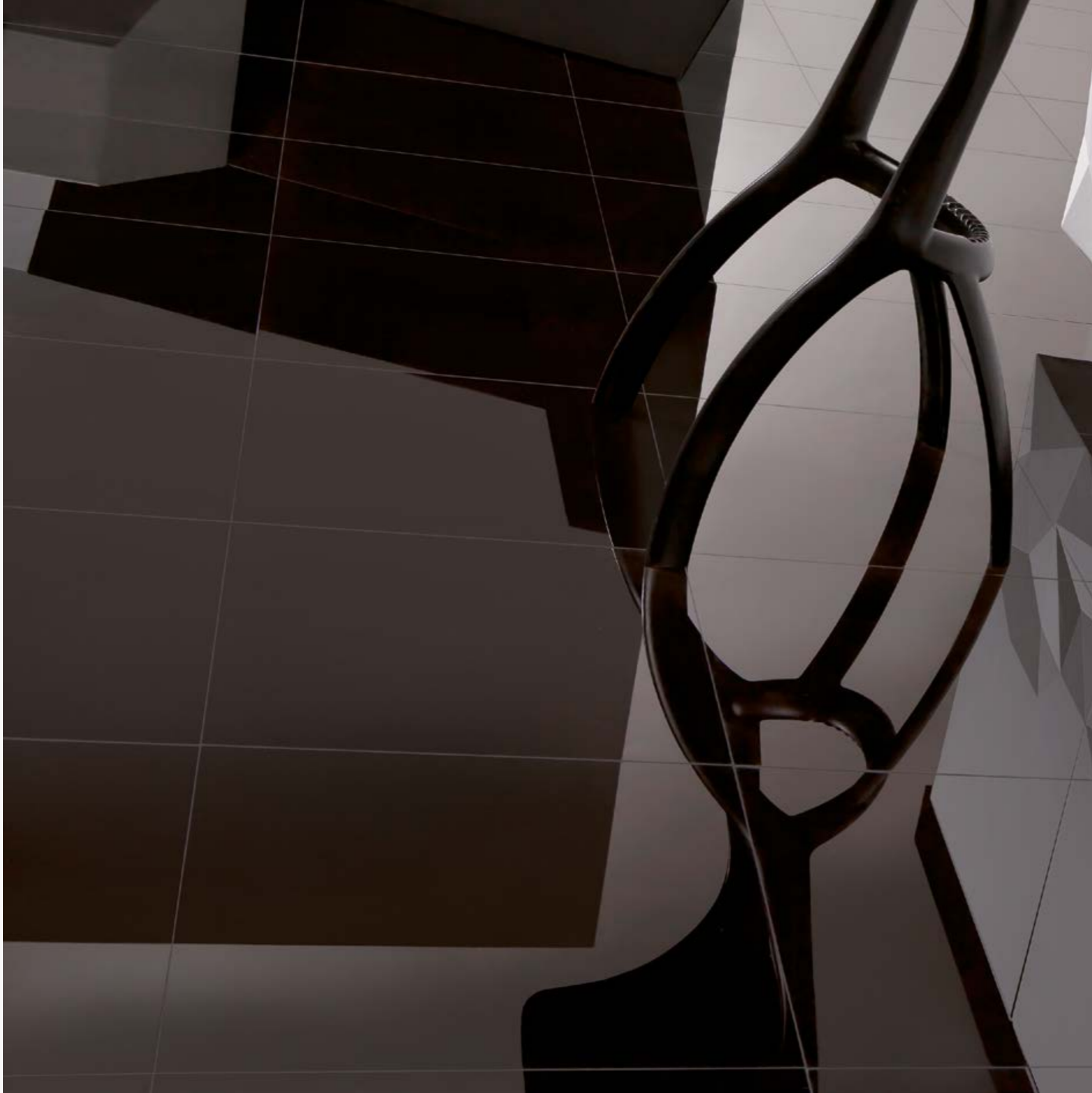

Led



Led

Colors / Colores

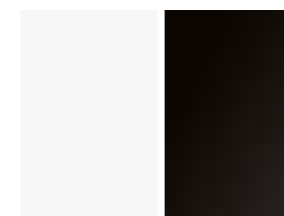

W

N

Finished / Acabados



premium polished

polished

Dimensions / Dimensiones

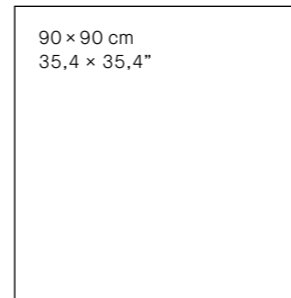

44 × 44 cm
17,3 × 17,3"

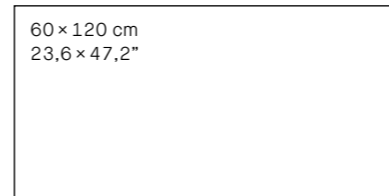

References / Referencias

Price code

20311 LED-W/90/EP	M2
20819 LED-W/120/EP	M40
11708 LED-W/44/P	M42
11983 LED-N/44/P	M42



Concept





Concept

Colors / Colores



KROSS-V KROSS-N KURT

Finished / Acabados



premium polished

Dimensions / Dimensiones

60 × 60 cm
23,6 × 23,6"

KROSS
10 patterns

KURT
5 patterns
Shade variation: V3

References / Referencias

20438 KROSS-V/60x60/P
20437 KROSS-N/60x60/P
17233 KURT/60/P

Price code

M46
M46
M46



Bansky





Banksy

Colors / Colores



BANSKY

Finished / Acabados



premium polished

Dimensions / Dimensiones

44 × 44 cm
17,3 × 17,3"

68 patterns
Shade variation: V4

References / Referencias

09725 BANSKY/P (44x44 cm-17,3x17,3")

Price code

M43

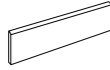
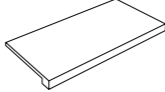
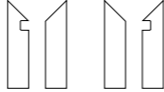
Name - Nombre	SKIRTING RODAPIÉ		TECHNICAL STAIR THREAD PELDAÑO TÉCNICO		S.K.I. S.K.D.	
Shape - Forma						
Size & Price - Formato y precio	8x100 (EP)	U48	30x100	U74	8x30	U53
	8x100 (NAT)	U45	30x100	U74	8x30	U53
	8x90	U44	30x90	U76	8x30	U53
	8x75	U43	30x150	U80	8x30	U55
	8x75,5	U43	30x151 (NAT)	U80	8x30	U53
	8x75,5	U43	30x151 (EP)	U86	8x30	U53
	8x75,5	U43	30x75,5 (NAT)	U70	8x30	U53
	8x75,5	U43	30x75,5 (EP)	U76	8x30	U53
	8x60 (P)	U45	30x120 (P)	U80	8x30 (P)	U55
	8x60	U35	30x120	U75	8x30	U53
	8x60 (P)	U45	30x60 (P)	U82	8x30 (P)	U55
	8x60	U35	30x60	U54	8x30	U53
	8x44	U38	30x44	U87	8x44	U58

Formato - Sizes	Cajas - Boxes			Pallet				Cont./20' 24000 Kg.		
	Piezas	m ²	kg	Cajas	m ²	kg	Tamaño cm aprox	Nº pallets	m ²	kg
75,5 x 151 x 1,2	1	1,14	30,70	38	43,32	1211,60	160 x 92 x 76	17	736,44	20597,20
19,5X150 x 0,8	4	1,17	23,10	48	56,16	1153,80	160 x 92 x 54	17	954,72	19614,60
60 x 120 x 1,2 (EP)	2	1,44	38,30	27	38,88	1058	120 x 80 x 75	22	855	23278
60 x 120 x 1,2 (NAT)	2	1,44	38,30	27	38,88	1058	120 x 80 x 75	22	855	23278
19,5 x 120 x 1,15	3	0,70	19,70	50	35	1010	128 x 95 x 75	23	805	23230
100 x 100 x 0,8	2	2	36,80	32	48	925	112 X 100 X 64	26	1248	24055
90 x 90 x 1,2 (EP)	1	0,81	22,25	36	29,16	826	105 x 95 x 75	29	846	23954
90 x 90 x 1,05 (NAT)	1	0,81	21	40	32,40	865	105 x 95 x 75	27	875	23355
50 x 100 x 0,8	3	1,50	28,20	24	36	702	120 X 80 X 66	33	1188	23159
60 x 60 x 1,2	3	1,08	29,64	30	32,40	914	120 x 80 x 75	26	842	23769
60 x 60 x 1	3	1,08	24,11	36	38,88	893	120 x 80 x 75	26	1011	23218
45 x 90 x 1,05	2	0,81	19,19	36	28,92	639	100 x 100 x 59	37	1070	23646
44 x 44 x 1,05	5	0,97	23,20	64	62,08	1510	120 x 80 x 102	15	931	22647
30 x 60 x 0,95	5	0,90	18,70	48	43,20	923	120 x 80 x 75	26	1123	23998
inch	Units	sq ft	lb	Boxes	sq ft	lb	Sizes inch approx.	Nº pallets	sq ft	lb
29,7 x 59,4 x 0,47	1	12,27	67,54	42	466,29	2665,52	62,9 x 36,2 x 29,9	17	7926,97	45313,84
7,6 x 59 x 0,35	4	12,59	50,82	48	604,50	2538,36	62,9 x 36,2 x 21,2	17	10276,51	43152,12
23,6 x 47,2 x 0,47 (EP)	2	15,50	84,26	27	418,50	2327,60	47,2 x 31,4 x 29,5	22	9203,13	51211,6
23,6 x 47,2 x 0,47 (NAT)	2	15,50	84,26	27	418,50	2327,60	47,2 x 31,4 x 29,5	22	9203,13	51211,6
7,6 x 47,2 x 0,45	3	7,53	43,34	50	376,74	2222	50 x 37,4 x 29,5	23	8664,94	51106
39,3 x 39,3 x 0,35	2	21,53	80,96	24	516,67	2035	44,1 x 39,3 x 25,2	26	13433,35	52921
35,4 x 35,4 x 0,47 (EP)	1	8,72	48,95	36	313,88	1817,20	41,3 x 37,4 x 29,5	29	9106,26	52698,8
35,4 x 35,4 x 0,43 (NAT)	1	8,72	46,20	40	348,75	1903	41,3 x 37,4 x 29,5	27	9418,41	51381
19,6 x 39,3 x 0,31	3	16,15	62,04	24	387,50	1544,40	47,2 x 31,5 x 25,9	33	12787,51	50949,8
23,6 x 23,6 x 0,47	3	11,63	65,21	30	348,75	2010,80	47,2 x 31,4 x 30,3	26	9063,20	52291,8
23,6 x 23,6 x 0,39	3	11,63	53,04	36	418,50	1964,60	47,2 x 31,4 x 29,5	26	10882,30	51079,6
17,7 x 35,4 x 0,41	2	8,72	42,22	32	311,29	1405,80	47,2 x 31,4 x 44,4	37	11517,37	52021,2
17,3 x 17,3 x 0,41	5	10,44	51,04	64	668,22	3322	39,3 x 39,3 x 23,2	15	10021,19	49823,4
11,8 x 26,6 x 0,37	5	9,69	41,14	48	465	2030,60	47,2 x 31,4 x 30,3	26	12087,86	52795,6

TECHNICAL INFORMATION

CERTIFICATIONS AND AWARDS



Es una Declaración Ambiental de Producto de conformidad con la Norma UNE-EN ISO 14025 que proporciona información medioambiental basada en el ciclo de vida de nuestros productos.

An Environmental Product Declaration in compliance with the UNE-EN ISO 14025 standard, which provides environmental information based on the lifecycle of our products.

Umwelt-Produktdeklaration gemäß der Norm UNE-EN ISO 14025, die Umweltdaten basierend auf der Lebensdauer unserer Produkte enthält.

Il s'agit d'une Déclaration environnementale de produit conforme à la Norme UNE-EN ISO 14025 qui fournit une information environnementale basée sur le cycle de la vie de nos produits.

Настоящая Экологическая декларация удостоверяет соответствие продукции требованиям международного стандарта ИСО 14025 по представлению информации, полученной на основе оценки жизненного цикла наших изделий.



Sistema de certificación de edificios sostenibles desarrollado por el US Green Building. Nuestros productos pueden contribuir a la obtención de puntos para la obtención de la certificación LEED.

A sustainable building certification system developed by US Green Building. Our products can contribute to the obtainment of points for a LEED certificate.

Zertifizierungssystem für nachhaltige Gebäude, ausgearbeitet von US Green Building. Mit unseren Produkten können Sie Punkte zum Erhalt der LEED-Zertifizierung bekommen.

Système de certification de bâtiments durables mis au point par l'US Green Building. Nos produits peuvent contribuer à l'obtention de points pour la certification LEED.

Система сертификации «зеленого строительства», разработанная Американским Советом по Зеленым Зданиям. Наша продукция помогает получить баллы при сертификации LEED.



Declara la conformidad de nuestros productos con los requisitos establecidos en el Mercado CE que establece que un producto es evaluado antes de ser introducido en el mercado y que cumple con los requisitos de seguridad, salud y protección medioambiental aplicables.

This declares that our products comply with the stipulations of the CE marking, under which a product must be assessed before it is put on sale and comply with the applicable health, safety and environmental requirements.

Erklärt die Konformität unserer Produkte mit den für die CE-Kennzeichnung festgelegten Anforderungen, die bestimmen, dass ein Produkt vor seiner Lancierung auf den Markt bewertet wird und die geltenden Anforderungen bezüglich Sicherheit, Gesundheit und Umweltschutz erfüllt.

Ce signe garantit la conformité de nos produits dans le respect des exigences établies en vertu du Marquage CE selon lequel un produit est évalué avant d'être introduit sur le marché et satisfait les exigences de sécurité, santé et protection applicables sur le plan environnemental.

Подтверждает соответствие продукции требованиям маркировки CE. Перед выходом на рынок изделие проходит проверку на соответствие директиве ЕС о безопасности потребителей и охране здоровья и окружающей среды.



El Certificado CCC es un sistema de certificación obligatorio para las exportaciones a China que garantiza que los productos con baja absorción de agua (E<0.5%) cumplen con los requisitos aplicables de seguridad y calidad establecidos.

The CCC certificate is compulsory for products exported to China. It guarantees that products with a low water absorption rate (E<0.5%) comply with the applicable safety and quality requirements.

Das CCC-Zertifikat ist ein obligatorisches Zertifizierungssystem für Exporte nach China, mit dem gewährleistet wird, dass die Produkte mit geringer Wasseraufnahme (E<0,5 %) die festgelegten geltenden Anforderungen bezüglich Sicherheit und Qualität erfüllen.

Le Certificat CCC est un système de certification obligatoire pour les exportations vers la Chine, qui garantit que les produits à faible absorption d'eau (E<0,5%) satisfont les exigences applicables établies en matière de sécurité et de qualité.

Сертификат CCC является обязательным для экспорта продукции в Китай. Он гарантирует, что продукция с низким водопоглощением (E<0.5%) удовлетворяет требованиям к безопасности и качеству, установленным системой сертификации.



Etiqueta medioambiental para el mercado francés que informa sobre el contenido en COV's (Compuestos Orgánicos Volátiles). Declara que nuestros productos son de tipo A+, contribuyendo a un hábitat sano y respetuoso con el medioambiente.

An environmental label for the French market, which provides information on the VOC content (volatile organic compounds). It declares that our products are rated A+, contributing to a healthy environmentally-friendly habitat.

Umweltetikett für den französischen Markt, der über den Inhalt an VOC (flüchtige organische Verbindungen) informiert. Zertifiziert, dass unsere Produkte zum Typ A+ gehören und zu einem gesunden und umweltfreundlichen Habitat beitragen.

Étiquette environnementale pour le marché français qui informe de la teneur en COV (Composés organiques volatils). Elle déclare que nos produits sont de type A+ et contribuent à un habitat sain et respectueux envers l'environnement.

Экологическая этикетка, предназначенная для французского рынка. Информировает о содержании ЛОС (летучих органических соединений). Свидетельствует о том, что наша продукция относится к типу A+, способствуя поддержанию здоровой и экологически чистой среды обитания.

Technical information











UNE-EN.14411:2016 Norma - Norm		Gres porcelánico Porcelain tiles			
		ANEXO-ANNEX G			
UNE-EN-ISO 10545		GRUPO-GROUP Bla			
		7 ≤N<15 cm	N≥15 cm		
Longitud y anchura - Length and width		± 0,9 mm	± 0,6 %	± 2,0 mm	
		Valor declarado - Declared value			
Espesor - Thickness	Desviación W Desviation W	± 0,5mm	± 5%	± 0,5 mm	
	Rectitud de lados - Straightness of sides	± 0,75 mm	± 0,5 %	± 1,5 mm	
-2 Ortogonalidad - Rectangularity	Central - Centre	±0,75 mm	± 0,5 %	± 2,0 mm	
	Curvatura Curvature	Lateral - Edge	± 0,75 mm	± 0,5 %	± 2,0 mm
		Alabeo - Warpage	± 0,75 mm	± 0,5 %	± 2,0 mm
Aspecto superficial - Surface quality		95%			
-3	Absorción de agua - Water absorption	≤ 0,5 %			
-4	Fuerza de rotura en N Breaking strength, In N	e ≥ 7,5 mm	≥ 1300 N		
		e < 7,5 mm	≥ 700 N		
	Resistencia a la flexión N/mm² - Modulus of rupture, in N/mm²	Media-Average ≥ 35			
-9	Resistencia al choque térmico - Thermal shock resistance	Cumple - Pass			
-11	Resistencia al cuarteo - Crazing resistance	Cumple - Pass			
-12	Resistencia a la helada - Frost resistance	Cumple - Pass			
-13	Resistencia a ácidos y bases Resistance to acids and alkalis	Baja concentración Low concentration	Valor declarado - Declared value		
		Alta concentración High concentration	Valor declarado - Declared value		
	Productos domésticos y sales para piscinas Household chemicals and swimming pool salts	mín GB			
-14	Resistencia a las manchas - Resistance to stains	Mínimo clase - Minium class 3			
EN-101	Dureza Mohs - Hardness (Mohs scale)	Valor declarado - Declared value			
	Resistencia al deslizamiento - Slip resistance	Cuando se exija - When required			

alphabetical index

Artículo Item	Ref.	Tarifa price list	Formato Size (cm)	Formato Size (inch)	Pzs Caja pcs box	Peso Caja weight box	Pág.
S SUITE PEARL/75,5X151/EP	22126	M58	75,5x151	29 3/4x59 7/16	1	30,70	136
SUNSHINE-B/60X120/EP	18495	M40	60x120	23 5/8x47 1/4	2	38,30	207
SUNSHINE-B/90X90/EP	18669	M2	90x90	35 7/16x35 7/16	1	22,25	207
T T.FIDIAS-B/5/P	11882	U11	5x5	1 15/16x1 15/16	40	2,60	151
T.GINA/P	10546	U64	4x4	1 9/16x1 9/16	10	0,80	278
T.I.GINA/P	10543	U70	29x29	11 7/16x11 7/16	3	4,64	278
T.I.HETTANGIAN-B/90/EP	17338	U75	41x41	16 1/8x16 1/8	4	14,20	169
T.I.METROPOLITAN-B/90/EP	17372	U75	41x41	16 1/8x16 1/8	4	14,20	187
T.I.SOFIA/P	8143	U70	29x29	11 7/16x11 7/16	3	4,64	260
T.LOREN/P	8468	U64	4x4	1 9/16x1 9/16	10	0,80	260
T.LUXURY-N/60/P	11883	U11	5x5	1 15/16x1 15/16	40	2,60	151
T.LUXURY-N/P	10675	U8	3x3	1 3/16x1 3/16	40	1,01	283
T.PERSEPOLIS-M/44/P	13190	U8	3x3	1 3/16x1 3/16	40	2,45	272
T.PERSEPOLIS-M/60/P	13189	U11	5x5	1 15/16x1 15/16	40	2,28	272
T.SOFIA/P	8147	U69	7x7	2 3/4x2 3/4	10	1,30	260
TORANO BIANCO/60X120/EP	22011	M40	60x120	23 5/8x47 1/4	2	38,30	144
TORANO BIANCO/60X120/NAT/R	22012	M66	60x120	23 5/8x47 1/4	2	38	144
TORANO BIANCO/75,5X151/EP	21070	M58	75,5x151	29 3/4x59 7/16	1	30,70	144
TORANO BIANCO/75,5X151/NAT/R	21074	M59	75,5x151	29 3/4x59 7/16	1	30,70	144
TORANO BIANCO/90X90/EP	22061	M2	90x90	35 7/16x35 7/16	1	22,25	144
TORANO BIANCO/90X90/NAT/R	22062	M68	90x90	35 7/16x35 7/16	1	21	144
TRAP.GREYSTONE ARGENT/34,5X15/EP	23558	U28	34,5x15	5 7/8x13 9/16	10	15,20	81

Artículo Item	Ref.	Tarifa price list	Formato Size (cm)	Formato Size (inch)	Pzs Caja pcs box	Peso Caja weight box	Pág.
T TRAP.GREYSTONE ARGENT/34,5X15/NAT	23683	U28	34,5x15	5 7/8x13 9/16	10	15,20	81
TRAP.GREYSTONE SMOKE/34,5X15/EP	23562	U28	34,5x15	5 7/8x13 9/16	10	15,20	81
TRAP.GREYSTONE SMOKE/34,5X15/NAT	23684	U28	34,5x15	5 7/8x13 9/16	10	15,20	81
TRAP.MARQUINA BLACK/34,5X15/EP	23563	U28	34,5x15	5 7/8x13 9/16	10	15,20	91
TRAP.MARQUINA BLACK/34,5X15/NAT	23686	U28	34,5x15	5 7/8x13 9/16	10	15,20	91
TRAP.STATUARIO PLUS/34,5X15/EP	23564	U28	34,5x15	5 7/8x13 9/16	10	15,20	99
TRAP.STATUARIO PLUS/34,5X15/NAT	23685	U28	34,5x15	5 7/8x13 9/16	10	15,20	99
TRI.GREYSTONE ARGENT/17,2X15/EP	23557	U13	17,2x15	5 7/8x6 3/4	30	15,20	81
TRI.GREYSTONE ARGENT/17,2X15/NAT	23687	U13	17,2x15	5 7/8x6 3/4	30	15,20	81
TRI.GREYSTONE SMOKE/17,2X15/EP	23559	U13	17,2x15	5 7/8x6 3/4	30	15,20	81
TRI.GREYSTONE SMOKE/17,2X15/NAT	23688	U13	17,2x15	5 7/8x6 3/4	30	15,20	81
TRI.MARQUINA BLACK/17,2X15/EP	23560	U13	17,2x15	5 7/8x6 3/4	30	15,20	91
TRI.MARQUINA BLACK/17,2X15/NAT	23689	U13	17,2x15	5 7/8x6 3/4	30	15,20	91
TRI.STATUARIO PLUS/17,2X15/EP	23561	U13	17,2x15	5 7/8x6 3/4	30	15,20	99
TRI.STATUARIO PLUS/17,2X15/NAT	23690	U13	17,2x15	5 7/8x6 3/4	30	15,20	99
TUCCI BLACK/60X120/P	20387	M46	60x120	23 5/8x47 1/4	2	39,62	240
TUCCI BLACK/60X60/P	20577	M37	60x60	23 5/8x23 5/8	3	29,64	240
TUCCI GOLD/60X120/P	20388	M46	60x120	23 5/8x47 1/4	2	39,62	240
TUCCI GOLD/60X60/P	20578	M37	60x60	23 5/8x23 5/8	3	29,64	240
V VOGUE-B/120/P	12949	M46	60x120	23 5/8x47 1/4	2	39,62	245
Z ZAR-M/P	6427	M30	44x44	17 5/16x17 5/16	5	23,20	266

ICONOGRAPHY

	V1	Variación en tonalidad uniforme	Uniform shade	Variation de tons uniforme	Einheitliche Farbtonunterschiede	Общая вариация по тональности
	V2	Variación en tonalidad ligera	Slight shade variation	Variation de tons légère	Leichte Farbtonunterschiede	Легкая вариация по тональности
	V3	Variación en tonalidad media	Medium shade variation	Variation de tons moyenne	Mittlere Farbtonunterschiede	Средняя вариация по тональности
	V4	Variación en tonalidad pronunciada	Pronounced shade variation	Variation de tons prononcée	Starke Farbtonunterschiede	Сильная вариация по тональности
	Mate		Matte	Mat	Matt	матовая
	Brillo		Gloss	Brillant	Glänzend	глянец
	Malla		Mesh	Maille	Auf Netz	декоративный элемент на сетке
	Decorados y bases producidos con metales preciosos y/o esmaltes reactivos. Limpiar con productos de PH neutros y sin abrasivos	Decors produced with precious metals and/or reactive glazes. That is why they have to be cleaned with neutral and non-abrasive products	Decors fabriqués avec métaux précieux et/ou émaux réactifs. Nettoyer avec produits neutres et sans abrasifs	Dekorationen mit Metallanteilen. Achtung, nicht mit säurehaltigen Reinigern pflegen		декоративные элементы произведенные с нанесением ценных металлов и реактивных эмалей на поверхность декоров. После жат чистке только при помощи нейтральных чистящих средств, которые не содержат абразивных микрочастиц
	Vidrio		Glass	Verre	Glas	Стекло
	Revestimiento		Wall tiles	Revêtement	Wandfliesen	только настенная
	Metal		Metal	Métal	Metall	Металл

All colours and hues appearing in this catalogue should be considered approximate, only in view of the printing processes involved. The rights of all contents (texts, photographs, drawings, designs, etc.) of this catalogue remain the property of PERONDA GROUP, S.A (or, failing that, they have the corresponding permissions and authorizations of the owners). No part of this publication may be reproduced, stored in a retrieval system, or transmitted in any form or by any means, electronic, mechanical, photocopying, recording or otherwise, without the prior written permission of the copyright holders.

Debido a los procesos de impresión, los colores que aparecen en este catálogo deben considerarse aproximados, y no exactos. Los derechos de todos los contenidos (textos, fotografías, dibujos, diseños etc) del presente catálogo son propiedad de PERONDA GROUP, S.A (o en su defecto, cuentan con los correspondientes permisos y autorizaciones de sus titulares). No está permitida la reproducción total o parcial de esta publicación, ni su tratamiento informático, ni la transmisión de ninguna forma o por cualquier medio, ya sea electrónico, mecánico, por fotocopia, por registro u otros medios, sin el permiso previo y por escrito de los titulares del copyright.

MUSEUM

© PERONDA GROUP 2018
Av. Manuel Escobedo, 26.
12200 Onda (Castellón) España



museumsurfaces.com